

AXELENT

Machine guarding

Est. 1990



X-Guard is a complete machine guard series that complies with the amended Machinery Directive 2006/42/EC on fixed guards that came into force on 29 December 2009.

With its wide range of standard components and accessories, X-Guard is guaranteed to cover all your machine guard needs. Ever since X-Guard was launched it has been under constant development to meet the market need for smart solutions that comply with current directives and requirements.



X-Guard® – Panels

X-Guard has three types of panels - mesh, plastic and sheet metal. All three are supplied with mounting brackets.

Mesh panels

Our mesh panels come in two sizes of mesh, Premium 50x20 mm, Classic and Lite 50x30 mm.

The Premium is 2200 mm in height and comes in six widths.

The Classic comes in five heights. The panel with a height of 750 mm is only used as an extension panel to the other heights. The panels come in thirteen widths, with the exception of the 1300 mm panel, which comes in fourteen widths. The Lite comes in three heights and in 13 widths. The standard panel colour is RAL 9011 but customised colours are available upon request.

X-Guard Contour

Mesh panel X-Guard Contour has rounded corners, making it not only the perfect solution for confined but also sleek in design. These panels come in four heights and 90° angle.

Sheet metal and plastic panels

The X-Guard series also has a range of sheet metal and plastic panels. They come in two heights and different widths. Sheet metal panels come in standard colour RAL 9011 (Graphite black) and are also available with windows.

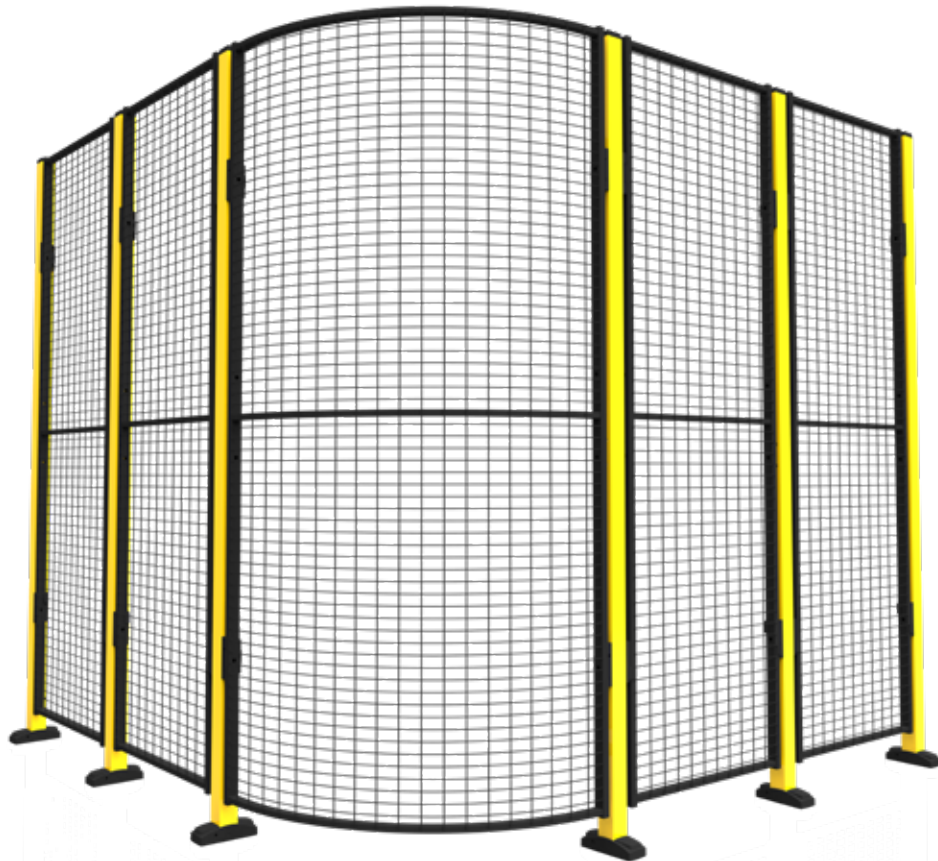

X-Guard® Contour

X-Guard Contour is a unique machine guard and has gone on to become a popular choice among our more traditional guards. The rounded panels are part of our X-Guard range and can be combined with other X-Guard components. X-Guard Contour is not only the perfect solution for confined but also sleek in design. These panels come in four heights.

Product facts X-Guard Contour

Safety distance	200 mm
Uprights	30x20 mm
Horizontals	25x15 mm
Posts	Classic 50x50 mm Premium 70x70 mm
Vertical wires	Ø 3 mm
Horizontal wires	Ø 2.5 mm
Mesh aperture	50x30 mm
Finish	Phosphatising/Epoxy paint
Colour mesh panel	Graphite black RAL 9011
Colour post Classic 50x50 mm	Zink yellow RAL 1018 Graphite black RAL 9011 Signal blue RAL 5005 Traffic red RAL 3020
Colour post Premium 70x70 mm	Zink yellow RAL 1018 Graphite black RAL 9011 Traffic red RAL 3020

(Other colours can be quoted.)

Mesh panels Contour 50x30 mm

Art.no	Height (mm)	Angle (degrees)
--------	-------------	-----------------

Graphite black (RAL 9011), rounded

W32R90-130	1300	90
W32R90-190	1900	90
W32R90-220	2200	90
W32R90-240	2400	90

(Fixings are included with all W32R- panels)

X-Guard® - Mesh Panels

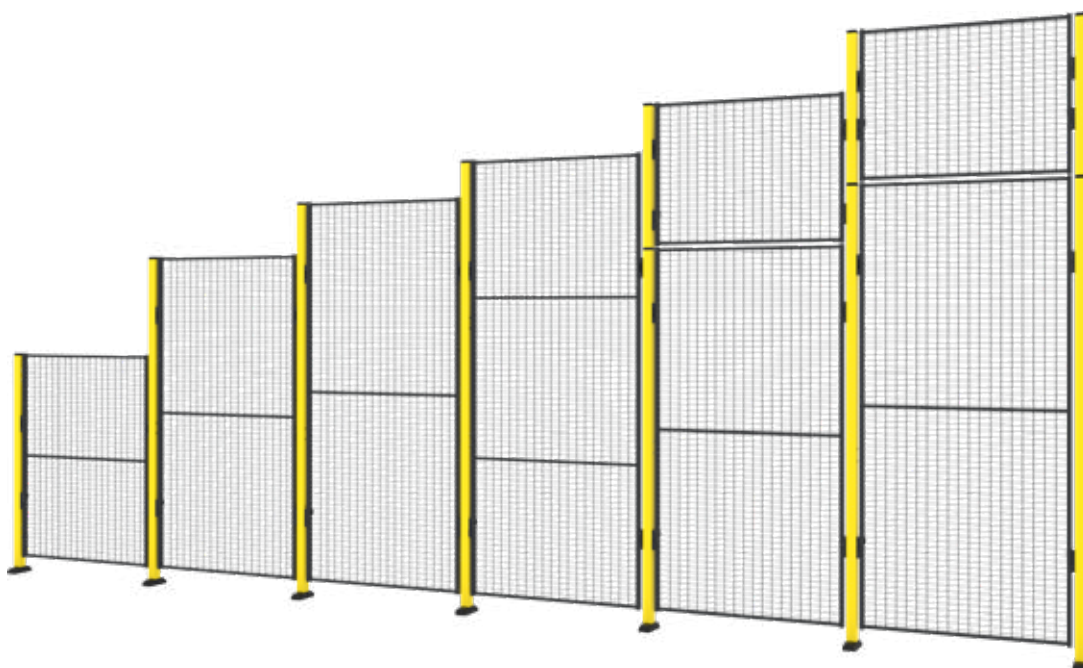

X-Guard standard colours

Posts Classic 50x50 mm



Zink yellow
RAL 1018



Graphite black
RAL 9011



Signal blue
RAL 5005



Traffic red
RAL 3020

Posts Premium 70x70 mm



Zink yellow
RAL 1018



Traffic red
RAL 3020



Graphite black
RAL 9011

Panels



Graphite black
RAL 9011

Mesh

In most environments and for most machines our mesh panels provide ample protection.

Our mesh panels comes in two sizes of mesh; 50x20 mm and 50x30 mm.

The safety distance determines the size of mesh required. The Classic 50x30 mm mesh requires a minimum distance of 200 mm while the Premium 50x20 mm requires only 120 mm.

Read more about the various coatings on page 42-43.

Product facts mesh panels

Safety distance	Classic 200 mm Premium 120 mm
Uprights	30x20 mm
Horizontals	25x15 mm
Posts	Classic 50x50 mm Premium 70x70 mm
Vertical wires	Ø 3 mm
Horizontal wires	Ø 2.5 mm
Mesh aperture	50x20 mm, 50x30 mm
Finish	Phosphatising/Epoxy paint
Colour mesh panel	Graphite black RAL 9011
Colour post Classic 50x50 mm	Zink yellow RAL 1018 Graphite black RAL 9011 Signal blue RAL 5005, Traffic red RAL 3020
Colour post Premium 70x70 mm	Zink yellow RAL 1018 Graphite black RAL 9011 Traffic red RAL 3020

(Other colours can be quoted)

Mesh panels Classic 50x30 mm

Art.no	Height (mm)	Width (mm)	Art.no	Height (mm)	Width (mm)
--------	-------------	------------	--------	-------------	------------

Graphite black (RAL 9011)

W322-075025	0750	0250
W322-075040	0750	0400
W322-075050	0750	0500
W322-075060	0750	0600
W322-075070	0750	0700
W322-075080	0750	0800
W322-075090	0750	0900
W322-075100	0750	1000
W322-075110	0750	1100
W322-075120	0750	1200
W322-075130	0750	1300
W322-075140	0750	1400
W322-075150	0750	1500

W322-190025	1900	0250
W322-190040	1900	0400
W322-190050	1900	0500
W322-190060	1900	0600
W322-190070	1900	0700
W322-190080	1900	0800
W322-190090	1900	0900
W322-190100	1900	1000
W322-190110	1900	1100
W322-190120	1900	1200
W322-190130	1900	1300
W322-190140	1900	1400
W322-190150	1900	1500

W322-240025	2400	0250
W322-240040	2400	0400
W322-240050	2400	0500
W322-240060	2400	0600
W322-240070	2400	0700
W322-240080	2400	0800
W322-240090	2400	0900
W322-240100	2400	1000
W322-240110	2400	1100
W322-240120	2400	1200
W322-240130	2400	1300
W322-240140	2400	1400
W322-240150	2400	1500

(Fixings are included with the panels)

Graphite black (RAL 9011)

W322-130025	1300	0250
W322-130040	1300	0400
W322-130050	1300	0500
W322-130060	1300	0600
W322-130070	1300	0700
W322-130080	1300	0800
W322-130090	1300	0900
W322-130100	1300	1000
W322-130110	1300	1100
W322-130120	1300	1200
W322-130130	1300	1300
W322-130140	1300	1400
W322-130150	1300	1500
W322-130220	1300	2200

W322-220025	2200	0250
W322-220040	2200	0400
W322-220050	2200	0500
W322-220060	2200	0600
W322-220070	2200	0700
W322-220080	2200	0800
W322-220090	2200	0900
W322-220100	2200	1000
W322-220110	2200	1100
W322-220120	2200	1200
W322-220130	2200	1300
W322-220140	2200	1400
W322-220150	2200	1500

Mesh panels Premium 50x20 mm

Art.no	Height (mm)	Width (mm)
--------	-------------	------------

Graphite black (RAL 9011)

W521-220025	2200	0250
W521-220040	2200	0400
W521-220070	2200	0700
W521-220100	2200	1000
W521-220120	2200	1200
W521-220150	2200	1500

(Extended lead time needs to be taken in account.
Fixings are included with the panels)

X-Guard standard colours

Posts Classic 50x50 mm



Zink yellow
RAL 1018



Graphite black
RAL 9011



Signal blue
RAL 5005



Traffic red
RAL 3020

Posts Premium 70x70 mm



Zink yellow
RAL 1018



Traffic red
RAL 3020



Graphite black
RAL 9011

Panels



Graphite black
RAL 9011



Sheet metal and plastic

Some environments require more comprehensive protection such as see-through plastic walls or sheet metal covered walls. X-Guard Plastic and Sheet Metal systems are easy to fit and you can use the same posts. To avoid gaps between the section and post we recommend you fit our custom edging plate included with the purchase of sheet metal or plastic panels (see accessories on 28). The plastic walls are heat resistant up to 60° C and available in clear plastic. Our standard height is 2200 mm and the extension height of 750 mm. Panels in heights of 1900 mm and 2400 mm are available on request.

Panel with window

When a process needs to be monitored then a windowed panel is the perfect solution. The window is available in clear or coloured plastic, the latter to protect against welding flashes. The coloured plastic meets safety standards EN ISO 25980:2014. Protection dark green is our standard. Our windowed panel comes in height of 2200 mm and in three widths as a standard. Panels in heights of 1900 mm and 2400 mm are available on request.

Product facts plastic- and sheetpanels

Uprights	30x20 mm
Horizontals	30x20 mm
Plastic	2 mm (thermoplastic polyester) 3 mm (polycarbonate) "protecting dark green"
Sheet metal	0,7 mm
Posts	Classic 50x50 mm Premium 70x70 mm
Colour panel	Sheet metal: Graphite black (RAL 9011) Plastic: transparent, frame in Graphite black (RAL 9011)
Colour post Classic 50x50	Zink yellow RAL 1018 Graphite black RAL 9011 Signal blue RAL 5005 Traffic red RAL 3020
Colour post Premium 70x70	Zink yellow RAL 1018 Graphite black RAL 9011 Traffic red RAL 3020

(Other colours can be quoted)

Plastic

Art.no	Height (mm)	Width (mm)	Art.no	Height (mm)	Width (mm)
W348-075025	0750	0250	W348-220025	2200	0250
W348-075040	0750	0400	W348-220040	2200	0400
W348-075080	0750	0800	W348-220080	2200	0800
W348-075100	0750	1000	W348-220100	2200	1000
W348-075120	0750	1200	W348-220120	2200	1200
W348-075150	0750	1500	W348-220150	2200	1500

(Fixings are included with the panels)

Sheet metal

Art.no	Height (mm)	Width (mm)	Art.no	Height (mm)	Width (mm)
Graphite black (RAL 9011)					
W349-075025	0750	0250	W349-220025	2200	0250
W349-075040	0750	0400	W349-220040	2200	0400
W349-075080	0750	0800	W349-220080	2200	0800
W349-075100	0750	1000	W349-220100	2200	1000
W349-075120	0750	1200	W349-220120	2200	1200

(Fixings are included with the panels)

Sheet metal with window (clear and welding green)

Art.no	Height (mm)	Width (mm)	Art.no	Height (mm)	Width (mm)
Clear · Graphite black (RAL 9011)			Protecting dark green · Graphite black (RAL 9011)		
W340-220080	2200	0800	W347-220080	2200	0800
W340-220100	2200	1000	W347-220100	2200	1000
W340-220120	2200	1200	W347-220120	2200	1200

(Fixings are included with the panels)

Door options for plastic and sheet panel

For installing a door with either plastic or sheet metal, a new special door panel can be ordered. The new special frame offers an easy installing of the door and an easy assembling of the lock. The different door options for plastic and sheet metal can be found on pages 13-20.



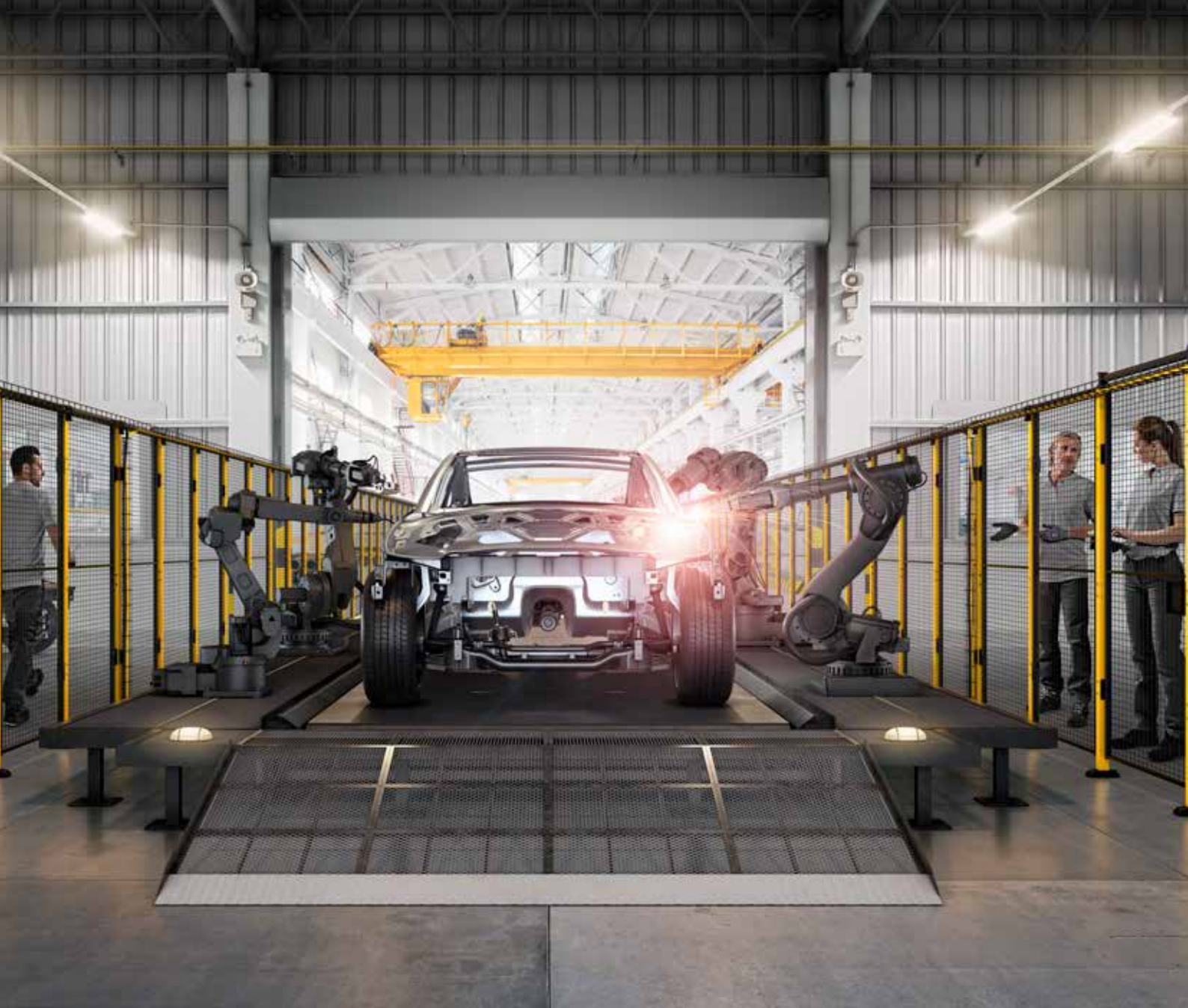

X-Guard® – Posts

X-Guard is available with two types of posts - Classic 50x50 mm and Premium 70x70 mm.

Classic 50x50 post

The Classic 50x50 mm post comes in four heights and has an extension piece of 750 mm. Colours range from RAL 1018 (Zink yellow), RAL 5005 (Signal blue), RAL 9011 (Graphite black) and RAL 3020 (Traffic red).

This post comes with a foot cover that hides the welded foot. It has a sleek design and makes cleaning so much easier.

Premium 70x70 post

The Premium 70x70 mm post comes in four heights and has an extension piece in four different heights. The standard colour is RAL 1018 (Zink yellow), RAL 9011 (Graphite black) and RAL 3020 (Traffic red) with a RAL 9011 (Graphite black) foot.

This post is shipped with a separate foot that can be fitted in two directions. This post is suitable when a more robust and higher machine guard is needed.

Both posts have holes punched on three sides to facilitate fitting, and a floor gap of 100 mm. Customised colours are available upon request.

Top plugs and expansion bolts for floor fixing are included with both posts.

Post prepared for push buttons

Axellent has developed X-Guard posts ready prepared for push buttons in a standard design. They make handling much easier and give a clean and tidy installation.

The post is equipped with a cover plate that doubles up as a guard against accidental activation.

The post comes in the types of Classic 50x50 mm and Premium 70x70 mm, and heights of 2000, 2300 and 2500 mm.

Posts

Art.no	Colour	Gap to floor (mm)	Height (mm)
--------	--------	-------------------	-------------

Classic 50x50 mm

P11-140	(RAL 1018)	100	1400
P11-200	(RAL 1018)	100	2000
P11-230	(RAL 1018)	100	2300
P11-250	(RAL 1018)	100	2500
P21-140	(RAL 5005)	100	1400
P21-200	(RAL 5005)	100	2000
P21-230	(RAL 5005)	100	2300
P21-250	(RAL 5005)	100	2500
P31-140	(RAL 9011)	100	1400
P31-200	(RAL 9011)	100	2000
P31-230	(RAL 9011)	100	2300
P31-250	(RAL 9011)	100	2500
P71-140	(RAL 3020)	100	1400
P71-200	(RAL 3020)	100	2000
P71-230	(RAL 3020)	100	2300
P71-250	(RAL 3020)	100	2500

Classic 50x50 mm

P11-148		180	1480
---------	--	-----	------

Premium 70x70 mm, Zink yellow (RAL 1018), Graphite black (RAL 9011), Traffic red (RAL 3020)

P13-140	(RAL 1018)	100	1400
P13-200	(RAL 1018)	100	2000
P13-230	(RAL 1018)	100	2300
P13-250	(RAL 1018)	100	2500
P33-140	(RAL 9011)	100	1400
P33-200	(RAL 9011)	100	2000
P33-230	(RAL 9011)	100	2300
P33-250	(RAL 9011)	100	2500
P73-140	(RAL 3020)	100	1400
P73-200	(RAL 3020)	100	2000
P73-230	(RAL 3020)	100	2300
P73-250	(RAL 3020)	100	2500

Extension 50x50 mm

E11-075, E11-075B	(RAL 1018)		0750
E21-075, E21-075B	(RAL 5005)		0750
E31-075, E31-075B	(RAL 9011)		0750
E71-075, E71-075B	(RAL 3020)		0750

(B, indicate that these extensions shall be used with the sliding doors.)

Extension Premium 70x70 mm

E13-075	(RAL 1018)		0750
E13-130	(RAL 1018)		1300
E13-190	(RAL 1018)		1900
E13-220	(RAL 1018)		2200
E33-075	(RAL 9011)		0750
E33-130	(RAL 9011)		1300
E33-190	(RAL 9011)		1900
E33-220	(RAL 9011)		2200
E73-075	(RAL 3020)		0750
E73-130	(RAL 3020)		1300
E73-190	(RAL 3020)		1900
E73-220	(RAL 3020)		2200

Post, push buttons

50x50 mm	(RAL 1018)	P11-200-A01	2000
50x50 mm	(RAL 1018)	P11-230-A01	2300
50x50 mm	(RAL 1018)	P11-250-A01	2500
70x70 mm	(RAL 1018)	P13-200-A01	2000
70x70 mm	(RAL 1018)	P13-230-A01	2300
70x70 mm	(RAL 1018)	P13-250-A01	2500



Foot Classic 50x50 mm

The Classic 50x50 post comes with a foot cover to hide the welded foot. Top plug and expansion bolt for floor fixing included. Floor gap 100 mm.



Foot Premium 70x70 mm

The Premium 70x70 post includes a Graphite black powder coated foot. It can be fitted in two different directions.

Top plugs and expansion bolts for floor fixing are included. Floor gap 100 mm.



Post, push buttons

The post (Classic 50x50 mm or Premium 70x70 mm) is prepared for up to 5 push buttons (not included). It is also equipped with a cover plate that doubles up as a guard against accidental activation.



X-Guard[®] Lite

X-Guard Lite is a simpler version of X-Guard. An excellent cost-effective alternative usually offers adequate protection.

Product facts mesh panels

Safety distance	200 mm
Uprights	19x19 mm
Horizontals	15x15 mm
Posts	50x50 mm
Vertical wires	Ø 3 mm
Horizontal wires	Ø 2.5 mm
Mesh apertures	50x30 mm
Finish	Phosphatising/Epoxy paint
Colour mesh panels	Graphite black RAL 9011
Colour post	Zink yellow RAL 1018

(Other colors can be quoted)



Accessories Lite

Art.no	Description
K1-12	Kit for optional placing of quick fittings, 1 pack
KHE-3-150	Cutting horizontal W=1500 mm (max)
10-9965	Plastic plug 19x19 mm, Graphite black
KVL-3-130	Vertical cutting package, X-Guard Lite, H = 1300 mm, RAL 9011
KVL-3-190	Vertical cutting package, X-Guard Lite, H = 1900 mm, RAL 9011
KVL-3-220	Vertical cutting package, X-Guard Lite, H = 2200 mm, RAL 9011
T00-27	Fittings X-Guard LITE, Ver.2
T06-3-13015	Infill sheet adjustable W=40-145mm, H=1300mm
T06-3-19015	Infill sheet adjustable W=40-145mm, H=1900mm
T06-3-22015	Infill sheet adjustable W=40-145mm, H=2200mm (only with quick fittings T00-27)
T90-06	X-Guard Lite Sample kit

Posts Lite

Art.no	Gap to floor (mm)	Height (mm)
Lite, 50x50 mm, Zink yellow (RAL 1018)		
P17-140	100	1400
P17-200	100	2000
P17-230	100	2300

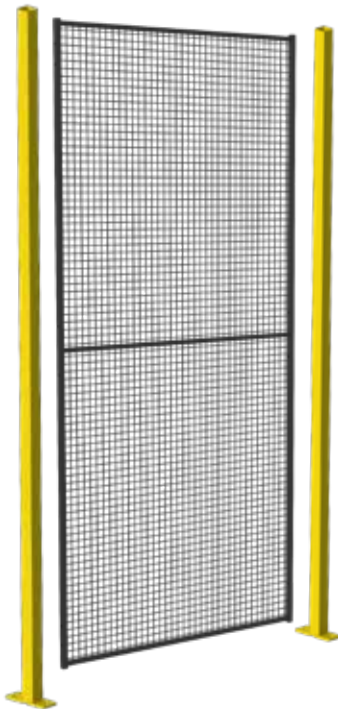

Mesh panels Lite

Art.no	Height (mm)	Width (mm)
Graphite black (RAL 9011)		
W312-130025	1300	0250
W312-130040	1300	0400
W312-130050	1300	0500
W312-130060	1300	0600
W312-130070	1300	0700
W312-130080	1300	0800
W312-130090	1300	0900
W312-130100	1300	1000
W312-130110	1300	1100
W312-130120	1300	1200
W312-130130	1300	1300
W312-130140	1300	1400
W312-130150	1300	1500
W312-190025	1900	0250
W312-190040	1900	0400
W312-190050	1900	0500
W312-190060	1900	0600
W312-190070	1900	0700
W312-190080	1900	0800
W312-190090	1900	0900
W312-190100	1900	1000
W312-190110	1900	1100
W312-190120	1900	1200
W312-190130	1900	1300
W312-190140	1900	1400
W312-190150	1900	1500
W312-220025	2200	0250
W312-220040	2200	0400
W312-220050	2200	0500
W312-220060	2200	0600
W312-220070	2200	0700
W312-220080	2200	0800
W312-220090	2200	0900
W312-220100	2200	1000
W312-220110	2200	1100
W312-220120	2200	1200
W312-220130	2200	1300
W312-220140	2200	1400
W312-220150	2200	1500



X-Guard® – Doors

X-Guard's door pack gives you easy and safe passage to and from the enclosed area. Whether you need to shift goods in and out or need access to carry out maintenance and service, X-Guard has doors to cover most eventualities. X-Guard is so versatile that you can swap a fixed panel for a door easily without having to move any posts. You do not need to concern yourself with whether the door should be left or right-hinged either (not X-Lock and X-It).

Our door packages can cover a variety of dimensions when paired with the required panel sizes. If you are swapping a fixed panel for a door just add a door package. If you are creating a door from scratch ensure you select the panels and posts you need too.

If there is a need for increased stability, you can use our 70x70 mm posts as an addition.

X-Guard® - Hinge Doors

Single hinge door, max opening 1500 mm.

Single hinge door (Classic 50x50 mm posts)					
Art.no	Height (mm)	Max width (mm)*	Description	Plastic & Sheet	
1. D10/DP10-XXX150A	Max 2500	1500	Single hinge door with top frame	x	
1. D10-XXX150B	Min 2755	1500	Single hinge door with top frame		
1. D11/DP11-XXX150A	Max 2500	1500	Single hinge door without top frame	x	
1. D11-XXX150B	Min 2755	1500	Single hinge door without top frame		

Single hinge door (Premium 70x70 mm posts)					
Art.no	Height (mm)	Max width (mm)*	Description	Plastic & Sheet	
1. D30/DP30-XXX150A	Max 2500	1500	Single hinge door, incl. top frame	x	
1. D30-XXX150B	Min 2755	1500	Single hinge door, incl. top frame		

Double hinge door, access for wider goods, pollet truck etc. max opening 2x1500 mm.

Double hinge door (Classic 50x50 mm posts)					
Art.no	Height (mm)	Max width (mm)*	Description	Plastic & Sheet	
2. D12-140300	1400	2x1500	Double hinge door		
2. D12-200300	2000	2x1500	Double hinge door		
2. D12/DP12-230300	2300	2x1500	Double hinge door	x	
2. D12-250300	2500	2x1500	Double hinge door		
2. D12-275300	2755	2x1500	Double hinge door		
2. D12-305300	3055	2x1500	Double hinge door		

Double hinge door (Premium 70x70 mm posts)					
Art.no	Height (mm)	Max width (mm)*	Description	Plastic & sheet	
2. D32-200300	2000	2x1500	Double hinge door		
2. D32/DP32-230300	2300	2x1500	Double hinge door	x	
2. D32-250300	2500	2x1500	Double hinge door		
2. D32-275300	2755	2x1500	Double hinge door		
2. D32-305300	3055	2x1500	Double hinge door		

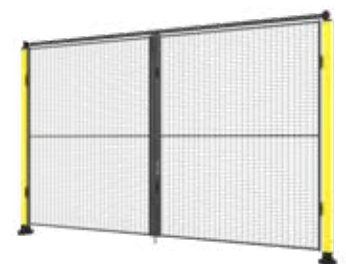
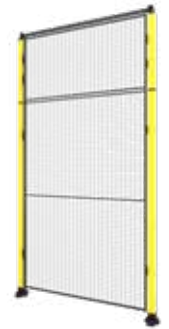

X-Guard® - Sliding Doors

Single sliding door, can be built with a max opening of 5700 mm.



Single sliding door (Classic 50x50 mm posts)

Art.no	Height (mm)	Max width (mm)*	Description	Plastic & Sheet
4. D20-XXX100A	Max 2500	900	Single sliding door	x
4. D20-XXX100B	Min 2755	900	Single sliding door	
4. D20-XXX140A	Max 2500	1400	Single sliding door	x
4. D20-XXX140B	Min 2755	1400	Single sliding door	
4. D20/DP20-XXX220A	Max 2500	2100	Single sliding door	x
4. D20-XXX220B	Min 2755	2100	Single sliding door	
4. D20/DP20-XXX310A	Max 2500	3000	Single sliding door	x
4. D20-XXX310B	Min 2755	3000	Single sliding door	
4. D20/DP20-XXX570A	Max 2500	5700	Single sliding door	x
4. D20-XXX570B	Min 2755	5700	Single sliding door	



Single sliding door (Premium 70x70 mm posts)

Art.no	Height (mm)	Max width (mm)*	Description	Plastic & Sheet
4. D40-XXX100A	Max 2500	900	Single sliding door	x
4. D40-XXX100B	Min 2755	900	Single sliding door	
4. D40-XXX140A	Max 2500	1400	Single sliding door	x
4. D40-XXX140B	Min 2755	1400	Single sliding door	
4. D40/DP40-XXX220A	Max 2500	2100	Single sliding door	x
4. D40-XXX220B	Min 2755	2100	Single sliding door	
4. D40/DP40-XXX310A	Max 2500	3000	Single sliding door	x
4. D40-XXX310B	Min 2755	3000	Single sliding door	
4. D40/DP40-XXX570A	Max 2500	5700	Single sliding door	x
4. D40-XXX570B	Min 2755	5700	Single sliding door	

Sliding door with centre lock, where the door blades are pushed in opposite directions. Maximum width is 5900 mm. Double sliding doors are a perfect solution where space is limited and when a door in the middle is required.

5



Sliding door with centre lock (Classic 50x50 mm posts)

	Art.no	Height (mm)	Max width (mm)*	Description	Plastic & Sheet
5.	D22/DP22-XXX290A	Max 2500	2900	Sliding door with centre lock	x
5.	D22-XXX290B	Min 2755	2900	Sliding door with centre lock	
5.	D22/DP22-XXX590A	Max 2500	5900	Sliding door with centre lock	x
5.	D22-XXX590B	Min 2755	5900	Sliding door with centre lock	

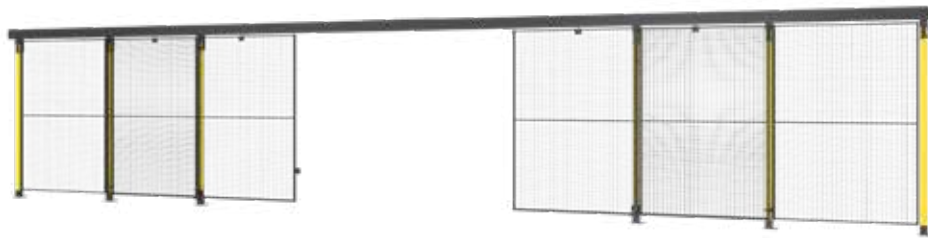

Sliding door with centre lock (Premium 70x70 mm posts)

	Art.no	Height (mm)	Max width (mm)*	Description	Plastic & Sheet
5.	D42/DP42-XXX290A	Max 2500	2900	Sliding door with centre lock	x
5.	D42-XXX290B	Min 2755	2900	Sliding door with centre lock	
5.	D42/DP42-XXX590A	Max 2500	5900	Sliding door with centre lock	x
5.	D42-XXX590B	Min 2755	5900	Sliding door with centre lock	

The combined hinged- and sliding door offers 2000 or 4000 mm wide opening in compact way. All the advantages of both door types are merged into one. The door has folding panels on wheels, which means that you quick and easily can open the door by sliding the door panels together and then folding them down.

6 a.



6 b.



Combined hinged- and sliding door (Premium 70x70 mm posts)

	Art.no	Max Height (mm)	Max width (mm)*	Description	Plastic & Sheet
6 a.	D56/DP56-XXX200A	2500	2000	Combined hinged- and sliding door	x
6 a.	D56-XXX200B	3055	2000	Combined hinged- and sliding door	
6 b.	D57/DP57-XXX400A	2500	4000	Hinged/sliding door with centre lock	x
6 b.	D57-XXX400B	3055	4000	Hinged/sliding door with centre lock	

Double sliding door with 2-step rail, is used where a large opening is required but where there is limited space at the side. The panels overlap each other instead of sliding to the side. Maximum width 2x1500 mm and maximum height 2500 mm.



Double sliding door with 2-step rail (Classic 50x50 mm posts)

Art.no	Height (mm)	Max width (mm)*	Description	Plastic & Sheet
7. D23-200300R	2000	2x1500	Double sliding door, right, with 2-step rail	
7. D23-200300L	2000	2x1500	Double sliding door, left, with 2-step rail	
7. D23-230300R	2300	2x1500	Double sliding door, right, with 2-step rail	x
7. D23-230300L	2300	2x1500	Double sliding door, left, with 2-step rail	x
7. D23-250300R	2500	2x1500	Double sliding door, right, with 2-step rail	
7. D23-250300L	2500	2x1500	Double sliding door, left, with 2-step rail	



Double sliding door with 2-step rail (Premium 70x70 mm posts)

Art.no	Height (mm)	Max width (mm)*	Description	Plastic & Sheet
7. D43-200300L	2000	2x1500	Sliding door, left with 2-step rail	
7. D43-200300R	2000	2x1500	Sliding door, right with 2-step rail	
7. D43-230300L	2300	2x1500	Sliding door, left with 2-step rail	x
7. D43-230300R	2300	2x1500	Sliding door, right with 2-step rail	x
7. D43-250300L	2500	2x1500	Sliding door, left with 2-step rail	
7. D43-250300R	2500	2x1500	Sliding door, right with 2-step rail	

Triple sliding door with 3-step rail, is used where a large opening is required but where there is limited space at the side. The panels overlap each other instead of sliding to the side. Maximum width 3x1500 mm and maximum height 2500 mm.



Triple sliding door with 3-step rail (Classic 50x50 mm posts)

Art.no	Height (mm)	Max width (mm)*	Description	Plastic & Sheet
8. D23-200450R	2000	3x1500	Triple sliding door, right, with 3-step rail	
8. D23-200450L	2000	3x1500	Triple sliding door, left, with 3-step rail	
8. D23-230450R	2300	3x1500	Triple sliding door, right, with 3-step rail	x
8. D23-230450L	2300	3x1500	Triple sliding door, left, with 3-step rail	x
8. D23-250450R	2500	3x1500	Triple sliding door, right, with 3-step rail	
8. D23-250450L	2500	3x1500	Triple sliding door, left, with 3-step rail	



Triple sliding door with 3-step rail (Premium 70x70 mm posts)

Art.no	Height (mm)	Max width (mm)*	Description	Plastic & Sheet
8. D43-200450L	2000	3x1500	Sliding door, left with 3-step rail	
8. D43-200450R	2000	3x1500	Sliding door, right with 3-step rail	
8. D43-230450L	2300	3x1500	Sliding door, left with 3-step rail	x
8. D43-230450R	2300	3x1500	Sliding door, right with 3-step rail	x
8. D43-250450L	2500	3x1500	Sliding door, left with 3-step rail	
8. D43-250450R	2500	3x1500	Sliding door, right with 3-step rail	

An overlapping sliding door is the perfect solution where space is limited. The sliding door can also be used when there are two output points from one machine. Available in sizes up to 2x2900 mm.

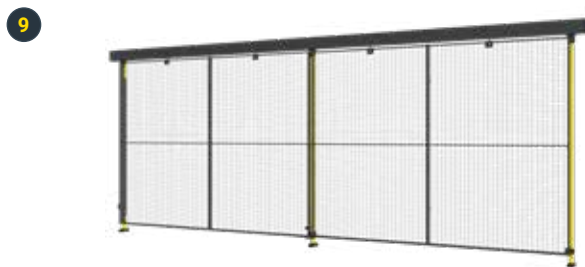

Double sliding door, overlapping (Classic 50x50 mm posts)

Art.no	Height (mm)	Max width (mm)*	Description	Plastic & Sheet
9. D24-200140	2000	2x1400	Double sliding door overlapped	
9. D24-230140	2300	2x1400	Double sliding door overlapped	x
9. D24-250140	2500	2x1400	Double sliding door overlapped	
9. D24-200290	2000	2x2900	Double sliding door overlapped	
9. D24/DP24-230290	2300	2x2900	Double sliding door overlapped	x



Double sliding door, overlapping (Premium 70x70 mm posts)

Art.no	Height (mm)	Max width (mm)*	Description	Plastic & Sheet
9. D44-200140	2000	2x1400	Double sliding door overlapped	
9. D44-200290	2000	2x2900	Double sliding door overlapped	
9. D44-230140	2300	2x1400	Double sliding door overlapped	x
9. D44/DP44-230290	2300	2x2900	Double sliding door overlapped	x
9. D44-250140	2500	2x1400	Double sliding door overlapped	
9. D44-250290	2500	2x2900	Double sliding door overlapped	

Sliding door without rail with centre lock, has an opening of almost 6 meters and no upper limitation. The door is perfect when handling large volumes carried by overhead crane or forklift. Maximum width 2x2900 mm and maximum height 2300 mm.

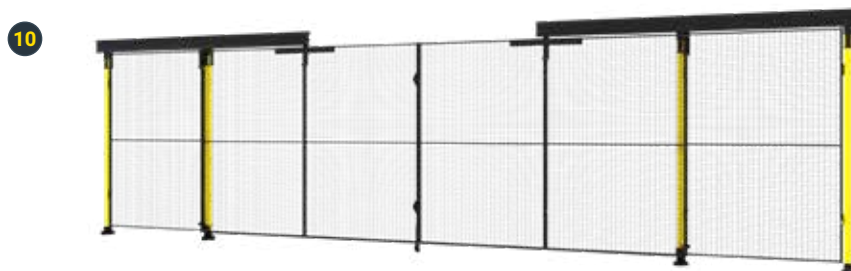

Sliding door without rail with centre lock

Art.no	Max Height (mm)	Max width (mm)*	Description
10. D47-XXX580	2300	2x2900	Sliding door without rail with centre lock

Single sliding door without upper rail. An ideal solution for an opening with no overhead obstruction and where the need for a large opening isn't necessary. Maximum widths 900 mm, 1400 mm and 2900 mm, maximum height 2300 mm.



Single sliding doors without upper rail (Classic 50x50 mm posts)					
	Art.no	Height (mm)	Max width (mm)*	Description	Plastic & Sheet
11 a.	D26/DP26-XXX090	2300	900	Single sliding door without upper rail	x
11 a.	D26/DP26-XXX140	2300	1400	Single sliding door without upper rail	x

Single sliding doors without upper rail (Premium 70x70 mm posts)					
	Art.no	Max Height (mm)	Max width (mm)*	Description	Plastic & Sheet
11 b.	D46/DP46-XXX090	2300	900	Single sliding door without upper rail	x
11 b.	D46/DP46-XXX140	2300	1400	Single sliding door without upper rail	x
11 b.	D46-XXX290	2300	2900	Single sliding door without upper rail	

Sliding door with centre lock, without upper rail are the perfect solution where unrestricted height clearance is required and where a large opening is needed. The door is a good choice where goods must be moved using an overhead travelling crane or forklift truck. Maximum widths 1800 mm and 2800 mm, maximum height 2300 mm.

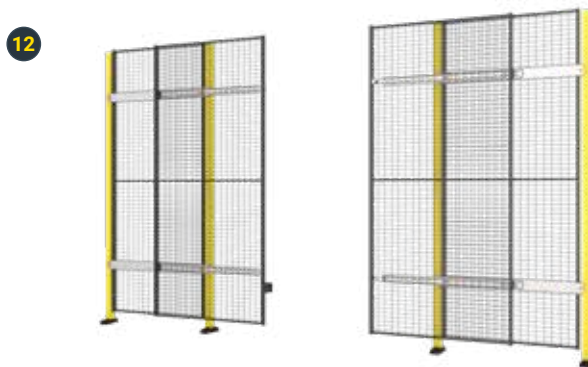

Sliding door without upper rail with centre lock					
	Art.no	Height (mm)	Max width (mm)*	Description	Plastic & Sheet
12.	D27/DP27-XXX180	2300	1800	Sliding door without upper rail with centre lock	x
12.	D27/DP27-XXX280	2300	2800	Sliding door without upper rail with centre lock	x

Single sliding door 2-step, without upper rail. Single sliding doors without rails are the ideal solution where objects higher than the rail need to pass through the opening. The door is a good choice when there is need for a wide opening. Maximum widths 1900 mm and 2900 mm, maximum height 2500 mm.



Single sliding door without upper rail					
Art.no	Height (mm)	Max width (mm)*	Description	Plastic & Sheet	
13.	D28-140190L	1400	1900	Single sliding door without upper rail left	
13.	D28-140190R	1400	1900	Single sliding door without upper rail right	
13.	D28-140290L	1400	2900	Single sliding door without upper rail left	
13.	D28-140290R	1400	2900	Single sliding door without upper rail right	
13.	D28-200190L	2000	1900	Sliding door without upper rail left	
13.	D28-200190R	2000	1900	Sliding door without upper rail right	
13.	D28-200290L	2000	2900	Sliding door without upper rail left	
13.	D28-200290R	2000	2900	Sliding door without upper rail right	
13.	D28/DP28-230190L	2300	1900	Sliding door without upper rail left	x
13.	D28/DP28-230190R	2300	1900	Sliding door without upper rail right	x
13.	D28/DP28-230290L	2300	2900	Sliding door without upper rail left	x
13.	D28/DP28-230290R	2300	2900	Sliding door without upper rail right	x
13.	D28-250190L	2500	1900	Sliding door without upper rail left	
13.	D28-250190R	2500	1900	Sliding door without upper rail right	
13.	D28-250290L	2500	2900	Sliding door without upper rail left	
13.	D28-250290R	2500	2900	Sliding door without upper rail right	

Sliding door 2-step without upper rail, centre lock. An ideal solution where unrestricted height clearance is required and where a large opening is needed. Maximum widths 3800 mm, 4800 and 5800 mm, maximum height 2500 mm.

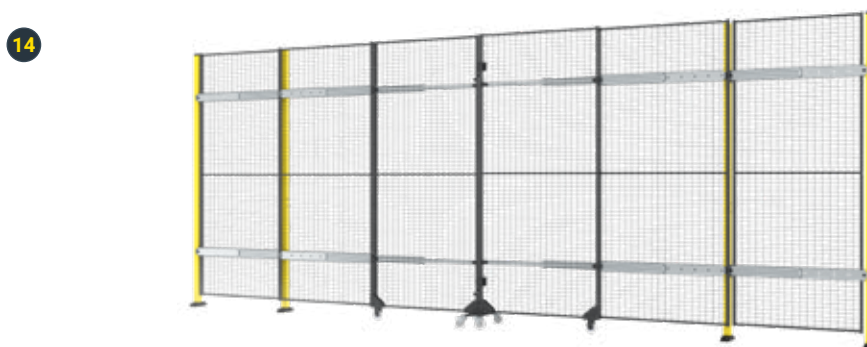

Sliding door 2-step without upper rail, centre lock					
Art.no	Max Height (mm)	Max width (mm)*	Description	Plastic & Sheet	
14.	D29/DP29-XXX380	2300	2x1900	Sliding door 2-step without upper rail, centre lock	x
14.	D29/DP29-XXX480	2300	1x2900+1x1900	Sliding door 2-step without upper rail, centre lock	x
14.	D29/DP29-XXX580	2300	2x2900	Sliding door 2-step without upper rail, centre lock	x

X-Guard® - Special doors

The X-Guard detachable hinge door is a mobile hinge door on wheels and meant to be operated the same way as a normal hinge door. This door is a smart option when space around the door is limited. If desired, just detach it and roll it aside. The rigid handlebar makes the door stable and easy to handle. Each support wheel has a parking brake.

15



Detachable hinge door

Art.no	Width of opening	Description
15. D13-XXX249	Detachable door, width of opening 1990-2490 mm	Detachable hinge door
15. D13-XXX565	Detachable door, width of opening 3400-5650 mm	Detachable hinge door

The high speed roll doors design is unique. The door roll is located on the back of the door. Moving parts are thus placed inside the cell, out of reach for the operator. Further, this design allows a forklift to get closer and deeper into the cell e.g. at tool exchange. The high speed roll door has long durability and low operating costs. In other words, it is a long-term and cost effective investment.

16



High speed roll door

Art.no	Height (mm)	Max width (mm)*	Description
16. S-0145-230150L / S-0145-230150R	2300	1500	High speed roll door (Rollback, motor L /motor R), CH=2300 mm, CW=1500 mm
16. S-0145-230200L / S-0145-230200R	2300	2000	High speed roll door (Rollback, motor L /motor R), CH=2300 mm, CW=2000 mm
16. S-0145-230250L / S-0145-230250R	2300	2500	High speed roll door (Rollback, motor L/motor R), CH=2300 mm, CW=2500 mm
16. S-0145-250150L / S-0145-250150R	2500	1500	High speed roll door (Rollback, motor L/motor R), CH=2500 mm, CW=1500 mm
16. S-0145-250200L / S-0145-250200R	2500	2000	High speed roll door (Rollback, motor L/motor R), CH=2500 mm, CW=2000 mm
16. S-0145-250250L / S-0145-250250R	2500	2500	High speed roll door (Rollback, motor L/motor R), CH=2500 mm, CW=2500 mm



X-Guard® – Locks

Axelent's X-Guard has flexible locking systems to suit all doors and switches/switch fittings in the machine guard series, from simple to more high tech solutions. X-Guard is so versatile in fact that you can swap a fixed panel for a door easily without having to move any posts. Combine a door pack with a locking system and create a door and locking solution to suit your needs.

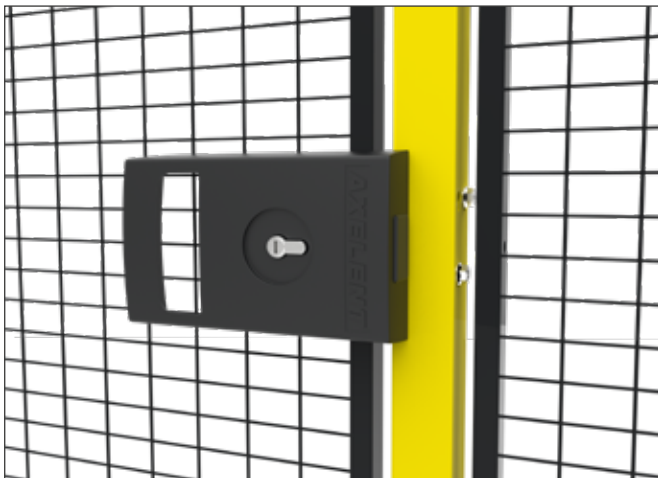

X-It

X-It cylinder lock is patented and available in several versions. Thanks to the unique design, no additional lock housing is required; just add a standard profile cylinder such as Euro. The lock is robust with a metal cover to withstand tough conditions and is tested and approved to EN 12209:2016.

The Lock is primarily designed for our modular mesh panel systems for machine guarding, industry and warehouses. The lock can also be used for similar third-party products/systems on the market. Assembly is easy; it is available for both hinge- and sliding doors in right and left versions.

X-It	
Art.no	Description
XIT-L01-101	X-It Cylinder lock, hinge door, LH
XIT-L01-301	X-It Cylinder lock, sliding door, left
XIT-L01-401	X-It Cylinder lock, sliding door with center lock, LH
XIT-R01-101	X-It Cylinder lock, hinge door, RH
XIT-R01-301	X-It Cylinder lock, sliding door, RH
XIT-R01-401	X-It Cylinder lock, sliding door with center lock, RH
XIT-L14-101	X-It "Slam Shut", esc.rel.function, hinge door, LH
XIT-L14-301	X-It "Slam Shut", esc.rel.function, sliding door, LH
XIT-L14-401	X-It "Slam Shut", esc.rel.function, sliding door center lock, LH
XIT-R14-101	X-It "Slam Shut", escape release function, hinge door, RH
XIT-R14-301	X-It "Slam Shut", escape release function, sliding door, RH
XIT-R14-401	X-It "Slam Shut", escape release function, sliding door center lock, RH
XIT-L09-101	X-It Electric, esc.rel.function, hinge door, LH
XIT-L09-301	X-It Electric, esc.rel.function, sliding door, LH
XIT-L09-401	X-It Electric, esc.rel.function, sliding door center lock, LH
XIT-R09-101	X-It Electric, esc.rel.function, hinge door, RH
XIT-R09-301	X-It Electric, esc.rel.function, sliding door, RH
XIT-R09-401	X-It Electric, esc.rel.function, sliding door center lock, RH

X-It Electric

X-It Electric can be used in various places within warehouse and production environments, preferable in relation to already installed access systems. In case of power failure the lock has an escape release function on the inside.

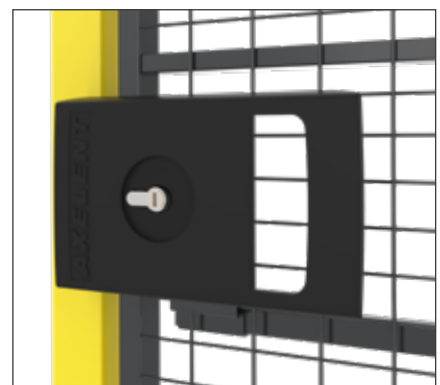

- Light to indicate open or locked
- Cylinder lock with mechanical key that overrides the electronic function
- Compatible with most electric access lock systems such as RFID, card readers, Pin code units etc.

- Storage temperature: -25 to +70 °C according to IEC 60068-2-14
- Operating temperature: -10 to +70 °C according to IEC 60068-2-14
- Housing IP rating: IP41
- Supply voltage: 12-24 VDC +/-10 % (regulated)

X-Guard® – Locks

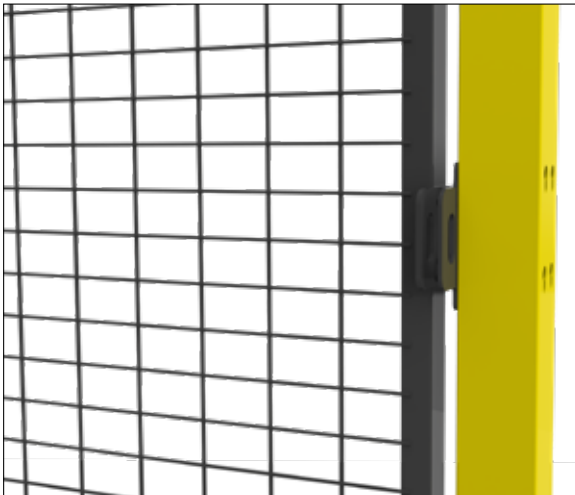

Padlock brackets

Padlock brackets are our very simplest lock system. A standard hinge lock prevents unauthorized access.



Snap lock

The door closes with a simple push and is kept closed by the built-in catch.

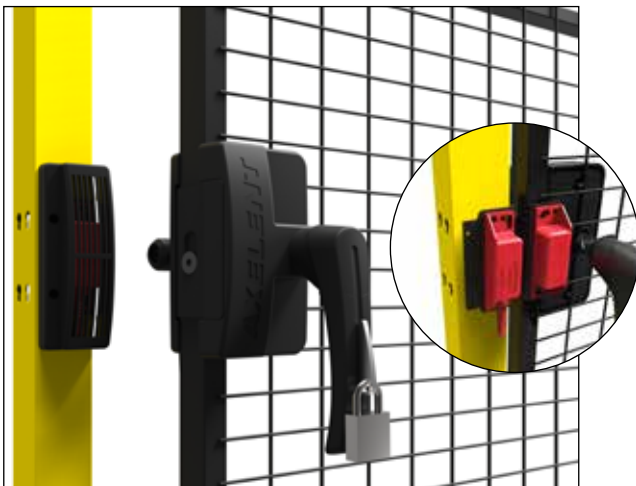

Hitch lock

This lock is an alternative to our X-lock and has an integrated mounting for non-contact switches. The lock has an adjustable hitch for eliminating any internal play. The handle is spring-loaded to remove the ability of the door to automatically fully close. To fully shut the door requires deliberate operation of the handle eliminating accidental closure. The external handle has an integrated padlock-loop which makes it possible to secure the door to prevent accidental closure when servicing or machine setting for example.

Note, padlock and/or switch are not included.

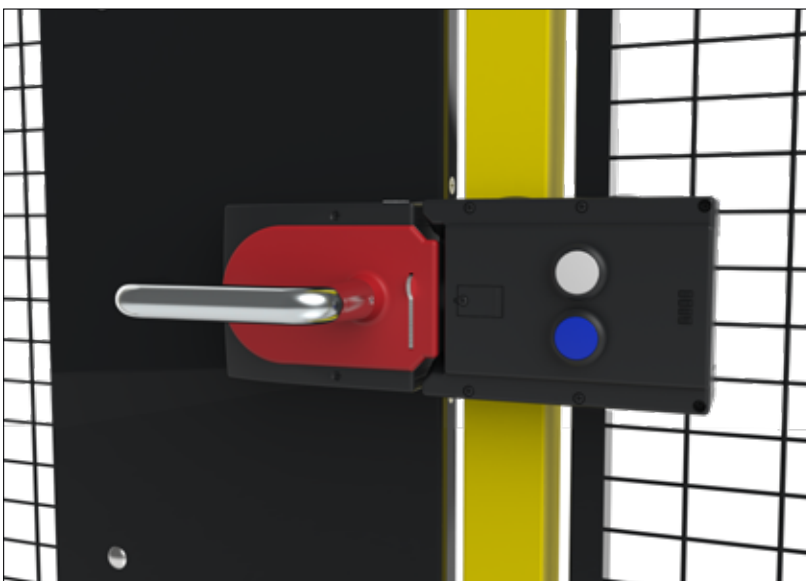

Euchner MGB

The MGB (Multifunctional Gate Box) is a unique interlock- and guard locking system for the protection of safety doors on machines and systems. Four LEDs indicate information about the lock status.

The lock has an intelligent plunge whose position is detected by an RFID transponder which has a unique code. This prevents tampering while allowing the MGB meets PL e EN ISO 13849-1 / SIL 3 according to EN 62061.

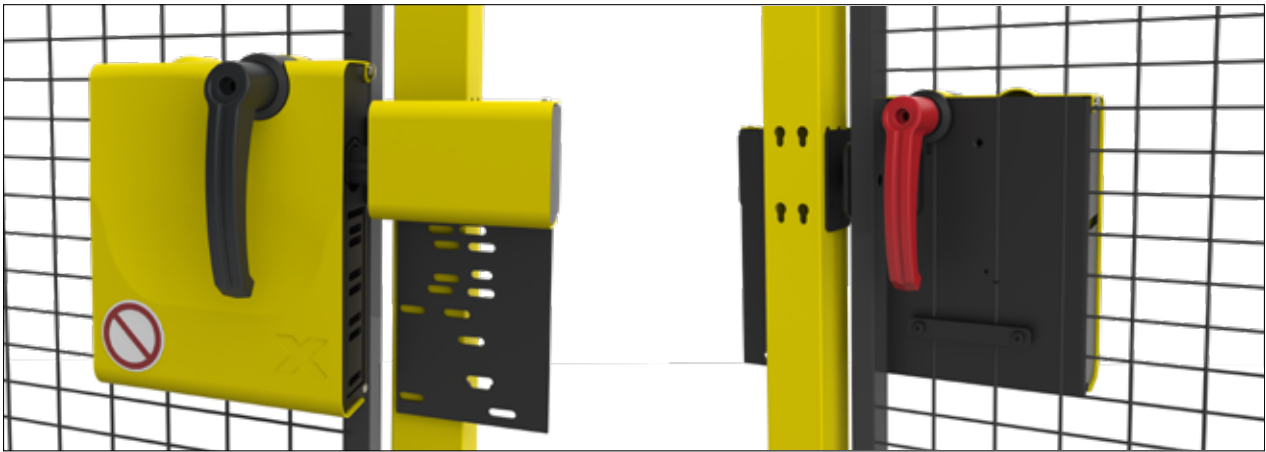

X-Lock

X-Lock is a versatile door lock system that suits all our accident prevention series. Using X-Lock and a door kit, you can transform any accident prevention panel into a door with a secure locking function.

X-Lock has a mechanical bolt that holds hinged and sliding doors closed. The lock is designed so that it requires conscious action to open and close the door from the outside. From the inside, X-Lock can not be closed. When locked, X-Lock can be opened from inside, unless a switch with guard locking is installed additionally.

Locks

Art.no	Description
L10-00-0	Padlock brackets for hinge door, right/left
L20-00-0	Padlock brackets for sliding door, right/left
L22-00-0	Padlock brackets for sliding door with centre lock
L10-05-0	Snap lock for hinge door, right/left
L20-05-0	Snap lock for sliding door, right/left
L22-05-0	Snap lock for sliding door with centre lock
L10-05-2	Hitch lock for hinge doors right/left
L20-05-2	Hitch lock for sliding doors right/left
L10-05-3	Cylinder lock, option for the handle to the hitch lock (1 each)
L66-20-L	X-Lock for all doors, left
L66-20-R	X-Lock for all doors, right
L66-21-L	X-Lock for all doors, left, for switch B-614
L66-21-R	X-Lock for all doors, right, for switch B-614
10-9540	Eurocylinder, DIN 18254, class 3
10-9545	Eurocylinder, DIN 18254, in system
10-9550	Eurocylinder (half), DIN V 18254
10-9551	Eurocylinder (half), DIN V 18254, in system

Switch/Emergency Stop

Axellent collaborates with several market leaders within the sector, including Allen-Bradley, GuardMaster, Euchner, Fortress, ABB Jokab, Omron, Pilz, Pizzato, Schmersal, Sick, Siemens and Telemecanique. This gives us a wide range to offer our customers for the safest and most optimum solution possible.



T10-01

Complete fittings for switch and key, hinge door, right/left

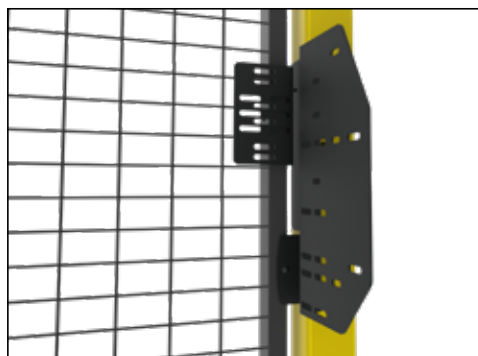

T10-12

Complete fittings for switch and key, hinge doors, right/left, Euchner



T10-13

Switch fitting hinge door, universal, non-contact

Safety switch fittings

Art.no	Description
T10-01	Complete fittings for switch and key, hinge door, right/left
T10-02	Complete fittings for switch and key, sliding door, right/left
T10-12	Complete fittings for switch and key, hinge doors, right/left, Euchner
T10-13	Switch fitting hinge door, universal, non-contact
T10-20	Complete fittings for switch and key, sliding doors, right/left
T10-23	Switch fitting single sliding door, universal, non-contact
T10-24	Switch fitting meeting sliding door, universal, non-contact
T10-30	Fittings, Euchner MGB hingedoor/slidingdoor, right/left
T10-31	Extra fittings for Euchner MGB with panic handle RAL 9011, X-Guard
T10-32	Fittings, Schmersal AZM200 hingedoor/slidingdoor, right/left
T10-33	Fittings, Euchner MGB Profinet Box hingedoor, right/left
T10-34	Fittings, Euchner MGB Profinet Box slidingdoor, right/left
T10-35	Extra MGB bracket, sliding door with centre locking, X-Guard
T10-36	Fittings (kit), Euchner MGB2 hingedoor, right/left
T10-37	Fittings (kit), Euchner MGB2 single sliding door, right/left

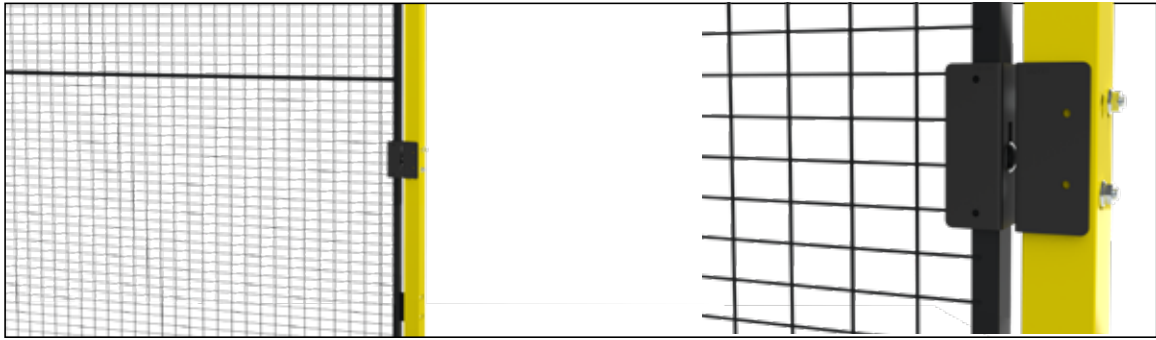

T10-30

Euchner MGB hinge door, right/left

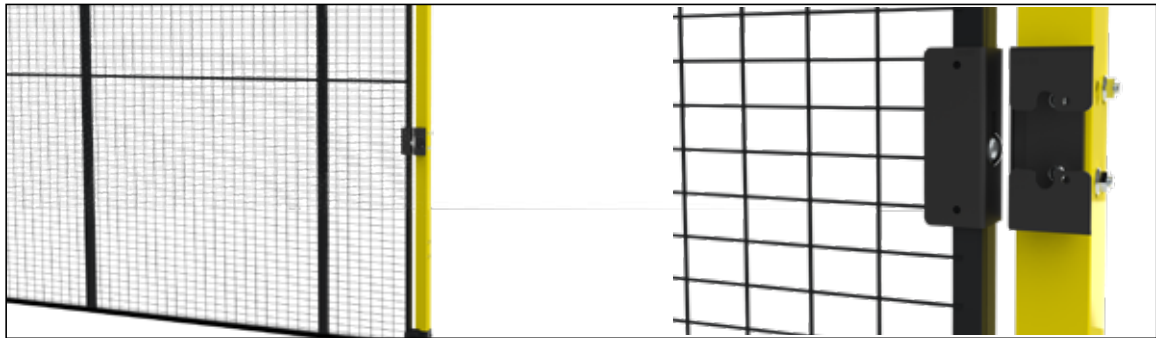

T10-30

Fittings, Euchner MGB slidingdoor, right/left

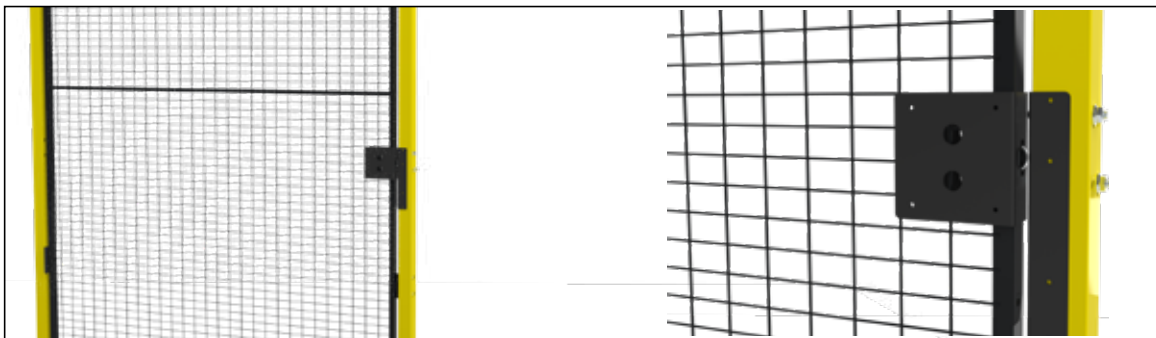

T10-32

Fittings, Schmersal AZM200 hingedoor, right/left

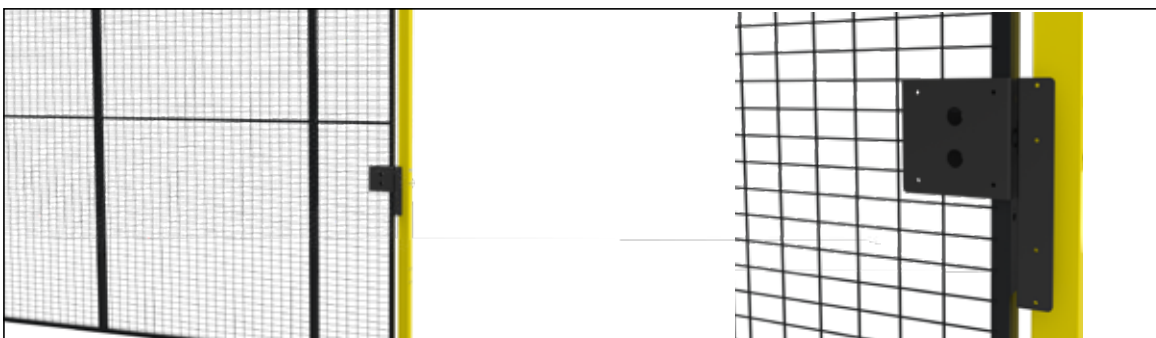

T10-32

Fittings, Schmersal AZM200 slidingdoor, right/left



X3-242-7 / X3-244-7 Tool Panel

X-Guard's Tool Panel enables you to keep all your tools and accessories needed to manage your machinery close at hand. The panel comes in heights of 1900 and 2200 mm and is 700 mm in width. The standard colour is RAL 9011. A host of accessories are available for hanging up tools.

More info and product sheets are available on our web page.

X-Guard® – Accessories

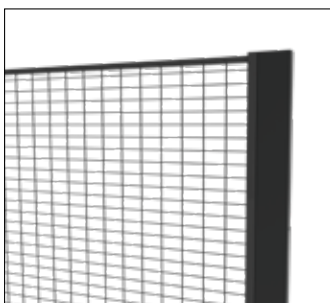

Infill sheet metal (Art No. see page 31)

An infill sheet metal functions as a filler when a guard needs a certain width. It comes in all heights and in 40 and 70 mm widths. Standard colour is RAL 9011 but customised colours are available upon request.



Adjustable infill (Art No. see page 31)

This adjustable infill piece covers gaps between 40 and 145 mm, offering greater flexibility. The 100 mm interval between our panels means less cutting of panels when an 'odd' gap needs to be filled. A stock item in RAL 9011, but other colours are available on request.

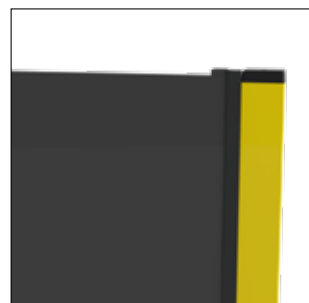

Cover strip (Art No. see page 31)

Strip to cover the gap between the post and panel. A Graphit black cover strip (RAL 9011) is included with sheet metal and plastic panels. It comes in heights of 750, 1900, 2200 and 2400 mm.



Kick plate (Art No. see page 32)

The Kick plate is available in lengths of 1000 mm and 1500 mm, for other lengths the plate has to be cut into the proper length on site during assembly. This Kick plate fits: X-Rail, X-Guard (Lite, Classic, Premium) and X-Store 2.0

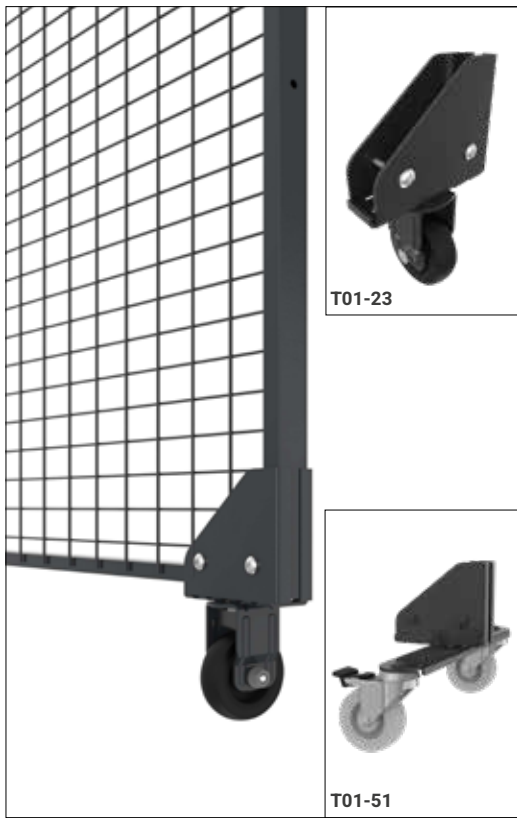

T01-23

T01-51

T01-23 / T01-51 Support wheel

An extra support wheel would not go amiss on some types of door solutions. Our range now includes a new smart support wheel that fits both hinged and sliding doors.



T01-27 Door closer

Automatic door closer for X-Guard's hinged door, including fittings. The fittings are reversible and suit both 50x50 and 70x70 mm posts.

NB There is some risk in using automatic door closers in combination with an interlock without manual reset. Door closers must therefore be evaluated in each individual case.

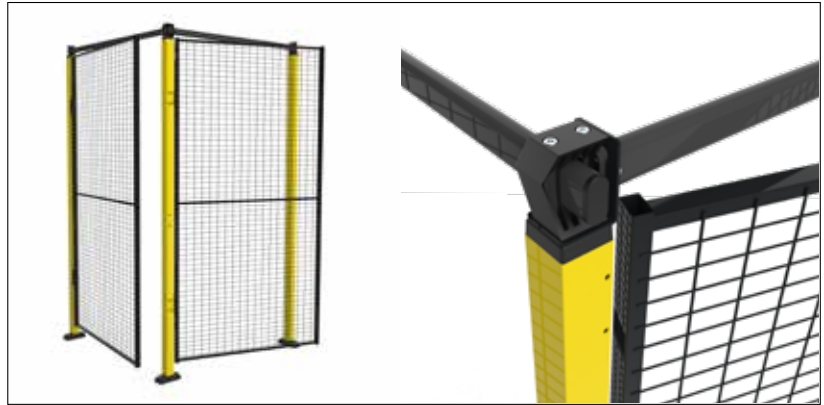

T01-05 Top frame fittings for doors in corners

A top frame fitting provides a more stable door construction for your machine guard. The width of the fitting is set during assembly. Top frame fittings are used for positioning two doors in a corner.



T01-22 Bail handle

Bail handle c/c 150 mm, set of 2 including mounting plates.

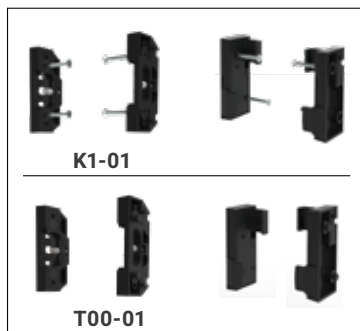

K1-01

T00-01

Quick fittings (Art No. see page 31)

A selection of brackets are available for X-Guard panels. These allow simple and quick attachment of panels to posts. The quick fittings has a top and a bottom attachment. The top fitting is a simple click-on fitting that can be fitted to three sides of the post. The click-on function means simple and above all quick fitting. Only one fitter is required to fit mesh panels to X-Guard machine guards. The lower fitting acts as a guide to steer the panel into the correct position. The panel is simply clicked into place in the top bracket, when it is in place. A quick fitting is also available for free positioning of the X-Guard post, see picture to the left (K1-01).



Cutting package (Art No. see page 31)

Panels may need to be cut to precise heights and widths in some environments. The X-Guard cutting pack will help you cut panels and is available in both vertical and horizontal versions.

The vertical comes in four heights; 750, 1300, 1900, 2200 and 2400 mm. The horizontal only comes in 1500 mm but is compatible with all widths and is available with or without attachments to allow unrestricted positioning. The standard cutting pack colour is Graphite black (RAL 9011) but customised colours are available upon request.

A rubber strip can be fitted to provide a soft and neat edge where mesh panels have been cut.

X-Guard® – Accessories

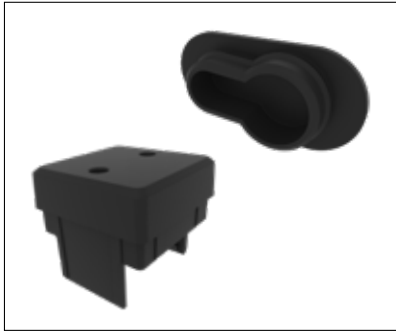

T01-17 / T01-13 Rubber plugs

Black rubber plugs can be used to cover unused holes in the post.



T01-06 Tube nut M8 (10-pack)

Tube nut M8 – This nut can be used when you have cut a panel and need to drill a new hole.

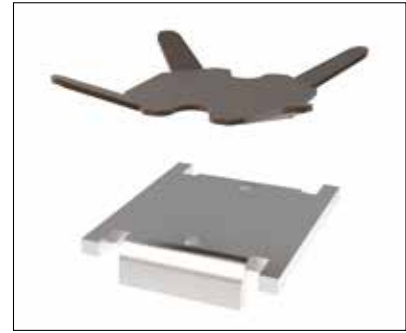

T01-28 Special nut (10-pack)

Nut plate set, for the top plug on the 50x50 mm post.



T01-08 Magnet

For use with 'Snap' close door locks.



T00-00-IN X-Key

X-Key is a unique tool for quick and easy panel release from inside the hazard zone. X-Guard panels can only be dismantled using an X-Key. (All panel and post orders include a key).



T00-00-EX X-Key

A unique but optional tool for quick external panel release. X-Guard panels can only be dismantled using an X-Key.



T01-04 (50x50) / T01-25 (70x70) Shims set

Used for adjusting the height of X-Guard posts where the floor is uneven. There are two different keys depending on the type of post you choose.

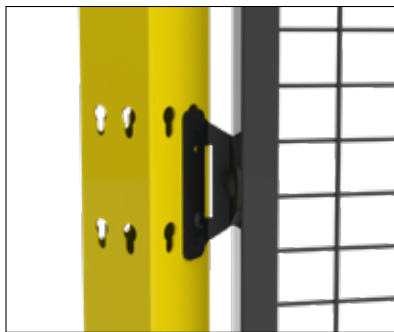

T01-01 0-180° Fitting

Fitting with an angle of up to 180°. This fitting is used where the machine guard needs to be set up at angles other than 90°.



T01-16 Foot cover

This foot cover consists of two pieces that are simply attached to each other. A foot cover is always supplied with a 50x50 post (not the 70x70).



X-Tray for X-Guard

Cable tray which fits X-Guard machine guarding perfectly. See page 32-41.



T01-07 X-Cup

Smart mug holder to fix to a post. (for 50x50 mm post only)

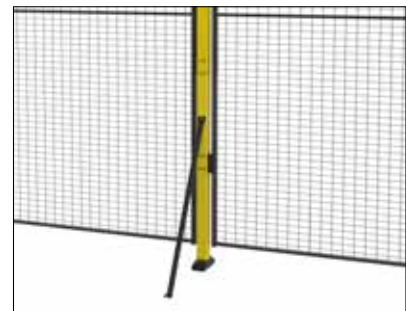

T01-09 Stabilization for contractor

Stabilization for contractor, RAL 9011.

Accessories

Art.no	Description
T00-00	X-Key
T00-01	Fittings for X-Guard, 1 pack
T00-02	Fittings for X-Guard, 1 pack, for 4 mm plastic panels
T00-03	Fittings for X-Guard, 1 pack, for 6 mm plastic panels
T00-04	Fittings for X-Guard, 1 pack, for horizontal panels
T00-05	Fittings for X-Guard, 1 pack, for horizontal panels different heights
T01-01	Fittings for creating corners up to 180°
T01-02	High impact protection for 50x50 mm post, 1 set/panel
T01-03	Special nut, for plastic cap on post, X-Guard, 10 pack
T01-04	Shim set, 2x2 mm + 1x6 mm, for post height adjustment X-Guard
T01-05	Special bracket when mounting 2 hinge doors in a corner
T01-06	Tube nut M8, 10 pack
T01-07	X-Cup holder
T01-08	Magnet
T01-09	Stabilization for contractor, Ral 9011
T01-11	Bolt upper panel bracket (zinc), not blocked, 10 pack
T01-13	Rubber plug for "keyhole" on X-Guard post (1set=36pcs)
T01-16	Foot cover for 50x50 post 5 kit (1 kit=2pcs)
T01-17	Top plug for 50x50 post (1 kit=5 pcs)
T01-18	Bracket for optional upper bar in corner, post 70x70mm
T01-19	Bracket for optional upper bar, 1kit/post, post 70x70mm
T01-21	Edge strip u-shaped, Graphite black rubber 30x26x15mm, 50m
T01-22	Bail handle c/c 150mm, set of 2 incl. mounting plates
T01-23	Support wheel incl. mounting plate. For floor gap 100mm, X-Guard
T01-24	X-Guard transp. securing kit (=4pcs) pre-assem. door, Classic+50x50mm
T01-25	Shim set for 70x70, 2x2mm + 2x4mm, for post adjustment X-Guard
T01-26	Bail handle c/c 122mm incl. screws for X-It, inside
T01-27	Automatic door closer, X-Guard hinge door
T01-28	Special nut, ver.2, (10 pack) post 50x50mm, X-Guard
T01-29	High impact protection for 70x70 post, 1set/panel, X-Guard
T01-30	Base for portable panel
T02-3-07504	Infill sheet metal H= 0750 W= 40 mm, RAL 9011
T02-3-07507	Infill sheet metal H= 0750 W= 70 mm, RAL 9011
T02-3-13004	Infill sheet metal H= 1300 W= 40 mm, RAL 9011
T02-3-13007	Infill sheet metal H= 1300 W= 70 mm, RAL 9011
T02-3-19004	Infill sheet metal H= 1900 W= 40 mm, RAL 9011
T02-3-19007	Infill sheet metal H= 1900 W= 70 mm, RAL 9011
T02-3-22004	Infill sheet metal H= 2200 W= 40 mm, RAL 9011
T02-3-22007	Infill sheet metal H= 2200 W= 70 mm, RAL 9011
T02-3-24004	Infill sheet metal H= 2400 W= 40 mm, RAL 9011
T02-3-24007	Infill sheet metal H= 2400 W= 70 mm, RAL 9011
T03-3-190	Cover strip, gap panel/post H= 1900 mm, RAL 9011
T03-3-220	Cover strip, gap panel/post H= 2200 mm, RAL 9011
T03-3-240	Cover strip, gap panel/post H= 2400 mm, RAL 9011
T04-3-075	Cover strip with clips H= 0750 mm, RAL 9011, 1 set/panel
T04-3-190	Cover strip with clips H= 1900 mm, RAL 9011, 1 set/panel
T04-3-220	Cover strip with clips H= 2200 mm, RAL 9011, 1 set/panel
T04-3-240	Cover strip with clips H= 2400 mm, RAL 9011, 1 set/panel
T05-3-13015	Infill, adjustable 40-145 mm. H =1300 mm complete, Ral 9011
T05-3-19015	Infill, adjustable 40-145 mm. H:1900 mm complete, Ral 9011
T05-3-22015	Infill, adjustable 40-145 mm. H: 2200 mm complete, Ral 9011
T05-3-24015	Infill, adjustable 40-145 mm. H: 2400 mm complete, Ral 9011
T08-3-100	Kit, Kick plate with end brackets L=1000mm
T08-3-150	Kit, Kick plate with end brackets L=1500mm
T08-3-100RE	Kit, Kick plate with end brackets L=1000mm, reinforced
T08-3-150RE	Kit, Kick plate with end brackets L=1500mm, reinforced
B00-057	X-Guard Sample kit
T20-200-001	Cable chain kit 8mm, sliding door H=2X00mm, 0-1000mm
T20-200-002	Cable chain kit 8mm, sliding door H=2X00mm, D3U1 1001-1400mm
T20-200-003	Cable chain kit 8mm, sliding door H=2X00mm, alu rail 1001-1500mm
T20-200-004	Cable chain kit 8mm, sliding door H=2X00mm, alu rail 1401-2200mm
T20-200-005	Cable chain kit 8mm, sliding door H=2X00mm, alu rail 2001-3100mm
T20-200-006	Cable chain kit 8mm, sliding door H=2X00mm, alu rail 3101-3600mm
T20-200-007	Cable chain kit 8mm, sliding door H=2X00mm, alu rail 2x1001-2x1500
T20-200-008	Cable chain kit 8mm, sliding door H=2X00mm, alu rail 3x1001-3x1500mm
T20-200-009	Cable chain kit 8mm, sliding door H=2000mm, movable alu rail

Art.no	Description
K1-01	Kit for optional placing of quick fittings, 1 pack
K1-03	Kit for optional placing of quick fittings upper bracket X-Guard, 1 pack
KVC-3-075	Cutting package vertical, H= 0750 mm, RAL 9011
KVC-3-130	Cutting package vertical, H= 1300 mm, RAL 9011
KVC-3-190	Cutting package vertical, H= 1900 mm, RAL 9011
KVC-3-220	Cutting package vertical, H= 2200 mm, RAL 9011
KVC-3-240	Cutting package vertical, H= 2400 mm, RAL 9011
KH-3-150	Cutting package horizontal, incl. fittings K1-01, W= 1500 mm, RAL 9011
KH-3-150B	Cutting package horizontal exkl. fittings K1-01, W= 1500 mm, RAL 9011
10-9841	Edge strip u-shaped, Graphite black rubber, 2 m
05-9501	Plastic plug 20x30 mm
X3-242-7	Toolpanel X-Guard H=1900 W=700mm, RAL9011
X3-244-7	Toolpanel X-Guard H=2200 W=700mm, RAL9011

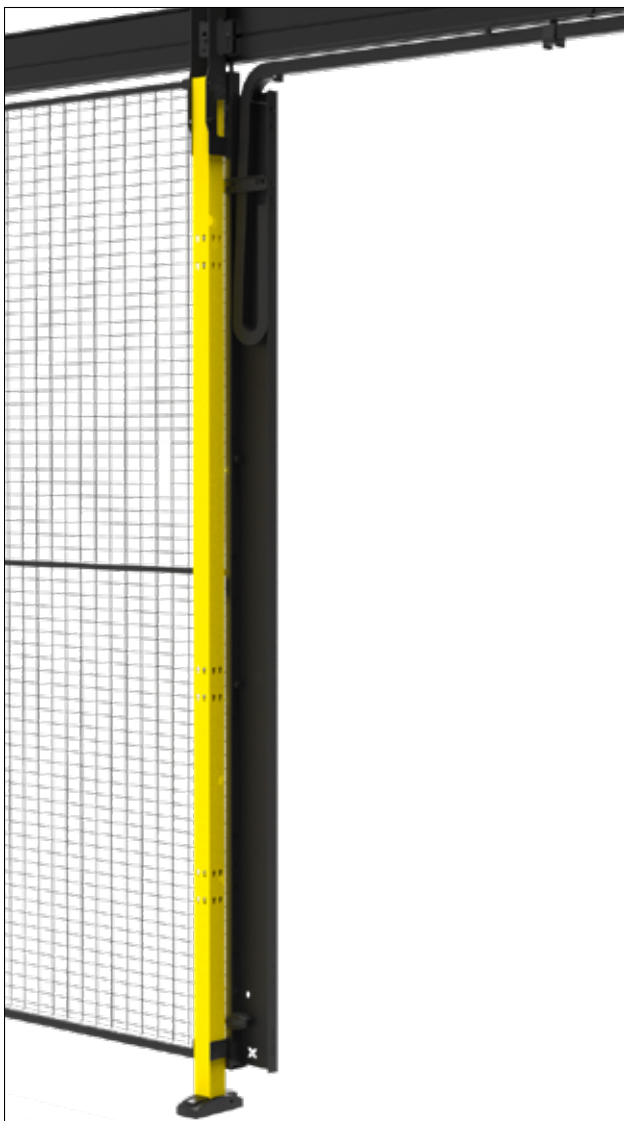

Cable chain

Smart and elegant solution for sliding doors when power is required on the movable door itself.

For example to a door interlock switch. Especially designed for double sliding doors locked in the centre, with or without an overhead rail, where a fixed post to attach a cabling is missing. A number of kits have been created depending on the system height, type of door and requested size of the opening. See list of all combinations and article no.



X-Tray - the natural choice with X-Guard

Strong, adaptable and easy to fit. Our cable trays in the combination with X-Guard gives near endless possibilities.

X-Tray cable trays is perfectly matched with our X-Guard machine guard. Combined they provide the optimal machine guarding solution. It can easily be drawn in our planning tool SnapperWorks when placing your order. X-Tray supports insulated electrical cables for power distribution, control and communication. Our cable trays enable elegant solutions with no special tools required. Just as with X-Guard, only a few brackets and tools are needed.

The perfect fit

Axellent's X-Tray is the ideal cable tray for X-Guard machine guard because they are perfectly matched for smooth installation to give a professional touch.

No special tools required

The combination is easy to assemble without the need for special tools. A 13 mm spanner is all you require.

One supplier

A turnkey solution from one supplier makes project implementation that much quicker and easier. It is also cost-effective because everything is bundled in the same shipment.

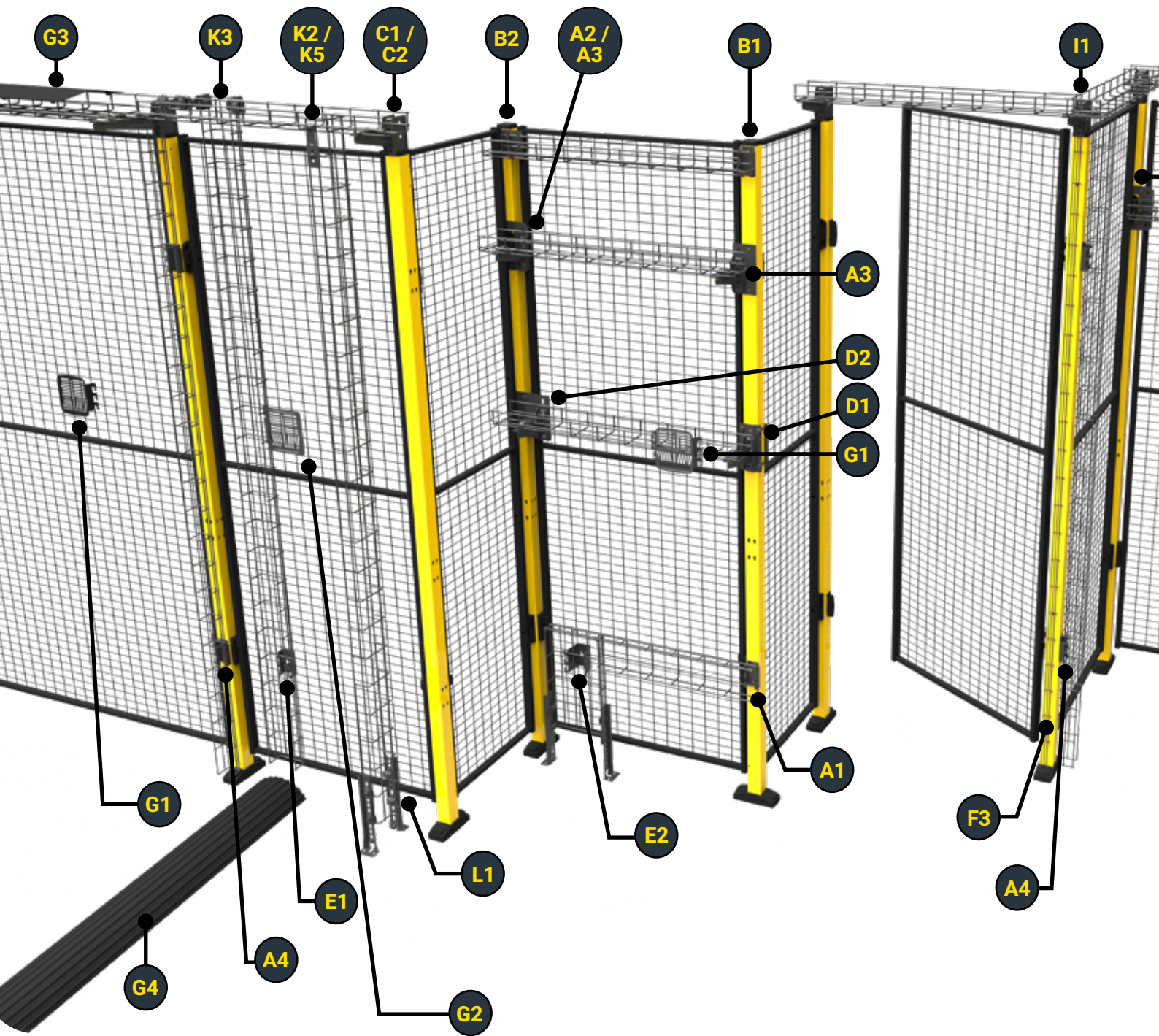

X-Tray complies with the highest demands on cable routing systems in



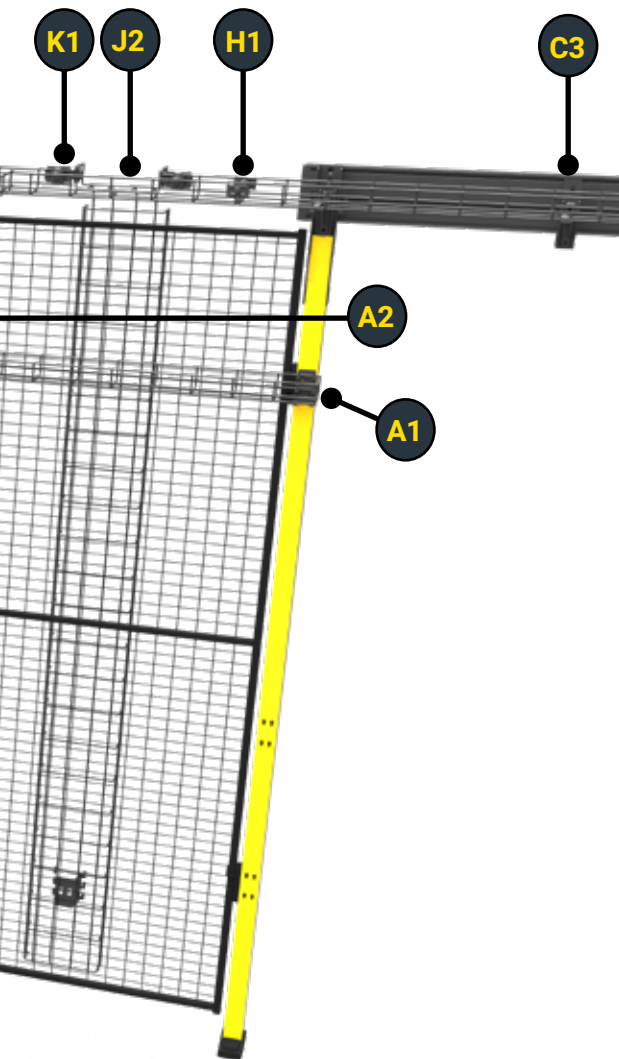

The possibilities

All cable trays and fittings are graphite black galvanized to match X-Guard's graphite black panels. The picture shows the various mounting possibilities and the letters guide you to items and installation instructions further on in the manual.

Item Numbers, see next pages »

Installations of X-Tray for X-Guard

- Max load: Cable trays 30 kg/m, Brackets 45 kg/each
- Max width of brackets: 420 mm
- X-Tray has the strongest quick joining on the market and the longest support distance of 2.25 m
- For side-hinged doors, X-Tray can replace the tubular frame for a stable installation of cable routing
- More information about X-Tray and fittings is available on our web page

The three most common installations

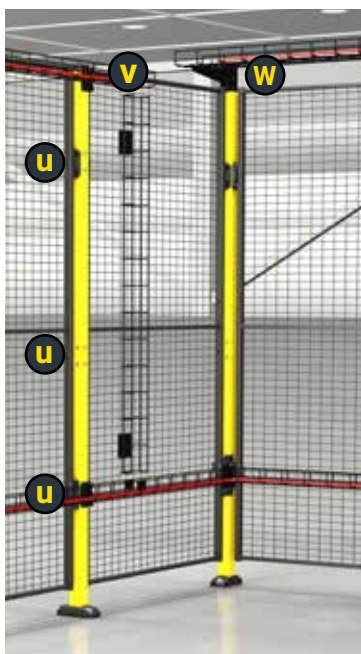

Mix all three for the best fit

u Keyhole mounting

For fast installations in the post keyholes. Trays 60-120 mm.

v Top mounting

Quick and discrete installation that follows X-Guard's top edge. Trays 60-120 mm.

w Cantilever mounting

This option gives a stable installation over the machine guard and most possibilities/solutions. The best solution for several doors/sliding doors. Trays 60-420 mm.

accordance with IEC 61537





X-Tray 60x60 L=2300 mm | Wire Ø 4

Item No. | 0701-2300



X-Tray 120x60 L=2300 mm | Wire Ø 5

Item No. | 0711-2300



X-Tray 220x60 L=2300 mm | Wire Ø 5

Item No. | 0721-2300



X-Tray 320x60 L=2300 mm | Wire Ø 5

Item No. | 0731-2300



X-Tray 420x60 L=2300 mm | Wire Ø 5/6

Item No. | 0741-2300

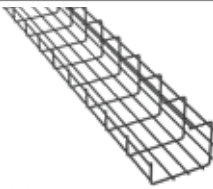

X-Tray G 120x150 L=2300 mm | Wire Ø 5

Item No. | 1722-2300

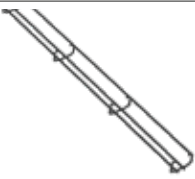

X-Tray Mini 30x22 L=2300 mm | Wire Ø 3

Item No. | 1752-2300

X-Tray Mini 30x22 L=1200 mm | Wire Ø 3

Item No. | 1752-1200



Post Bracket

Item No. | 7700-014

For 60-120 cm cable trays. Mounted in the post keyhole (A1 & A4). Together with Corner Post Bracket (7700-065) used in the internal corner (A2). Together with Top Corner Bracket (7700-066) used in the internal corner at the top of the post (A2) or anywhere else on the post.



Corner Bracket

Item No. | 7700-065

Used in the corner together with Post Bracket (7700-014) to put up cable trays (A2) or anywhere else on the post. You can also put a cantilever on it. Self-drilling screws and plugs supplied.



Post Bracket Top

Item No. | 7700-015

For 60-120 cm cable trays. Fixed to the top of the post (B1). If you bend up the top part 90° it can be screwed onto the post anywhere (F1). Self-drilling screws and plugs supplied.



Top Corner Bracket

Item No. | 7700-066

Used together with Post Bracket (7700-014) for mounting in a corner at the top of the post (B2). Self-drilling screws and plugs supplied. Bend tabs according to the instructions.



Cantilever Holder 50x50

Item No. | 7700-032

Item No. | 7700-032-2

Used for mounting cantilevers on the top of 50x50 posts (C1 + C4-6*). (*7700-032-2 - Only for special mounting. See page 14)



Cantilever Holder 70x70

Item No. | 7700-188

Item No. | 7700-188-2

Used to fix cantilevers to the top of 70x70 posts (C2 + C4-6*). (*7700-188-2 - Only for special mounting. See page 14)



X15 Cantilever

Item No. | 2715-Length

Bracket Holder (C1-2), Bracket Holder Aluminium Rail (C1), Adjustable Post Fitting (D1), Adjustable Corner Post Fitting (D2) and Bracket Holder Post (A3). Can be fixed to Corner Post Fitting (A2). Comes in four lengths 120, 220, 320 and 420.



Adjustable Post Fitting

Item No. | 7700-060

Screwed anywhere on the post to fix cantilevers (D2). Nuts and bolts supplied.



D

Adjustable Corner Post Fitting

Item No. | 7700-072

Screwed anywhere on the corner post to fix cantilevers (D2). Nuts and bolts supplied.



C

Cantilever Holder, aluminium rail

Item No. | 7700-037

To fix cantilevers on the aluminium rail over sliding doors (C3). Suitable for cantilever-mounted cable trays. Nuts and bolts supplied.



A

Post Cantilever Holder

Item No. | 7700-083

Used to mount X15 Cantilevers, mounted in the keyhole on the post (A3).



E

Mesh Panel Mini Bracket

Item No. | 7700-084

For mounting on mesh panels to bring the cable tray closer to the panel (E1). Used when vertical trays come inside a cantilever mounting.



E

Mesh Panel Bracket

Item No. | 7700-090

For mounting on mesh panels to bring a cable tray in line with cable trays mounted using a Post Bracket (7700-014) (E2).



A, B, C, D, F, H, I, K, L

X1 Fitting

Item No. | 2701

The X1 Fitting is used when making a corner (I1) or a Traffic reduction (H3). Used together with the X3 Angled Bracket (K1-4) or with other fittings, such as the X14 Pendant (L1) and X15 Cantilever (C1-3, D1-2).



I, J

X2 Fitting

Item No. | 2702

X2 Fitting is used on a corner with a large radius (I3) or on a drop from a horizontal to a vertical tray (J1).



I, K, L

X3 Angled Fitting

Item No. | 2703

For a T Junction (K1) or connecting to wall or floor (L2). If the cable tray needs to swing a few degrees, the angle of the X3 Angled Bracket can be adjusted (I2). It is also possible to join vertical and horizontal cable trays (K2-4).



B, K

X4 Fitting

Item No. | 2704

If you mount trays at the top of posts, you can raise the trays over side-hinged doors using the X4 Fitting together with the X1 Fitting (B3). Used for mounting a vertical cable tray underneath a horizontal (K2).



H

X5 Joining Fitting | 20 pack

Item No. | 2705

20-pack, nuts and bolts supplied. For joining cable trays. Bracket on the outside and bolt from the inside.(H1)



X61 Carriage Bolt M8x27 | 40 pack

Item No. | 2761

X62 Flange Nut M8 | 40 pack

Item No. | 2762



X10 Bracket

Item No. | 2710-1

To mount cable trays on the X11 Pendant or on a wall, a machine or similar. Suitable for 120 cm cable trays and 120-420 cm with the side up.



X10 Mini Bracket

Item No. | 2710-2

To mount cable trays on the X14 Pendant, a wall, a machine or similar. Suitable for 60 cm cable trays.



X11 Pendant | 240/480 mm

Item No. | 2711-240

Item No. | 2711-480

To mount cable trays with the help of the X10 Bracket or the X15 Cantilever.



X14 Pendant | 280 mm

Item No. | 2714-280

Used with the X10 Mini Bracket or to fix cable trays to a floor (L1).



X68 Equipotential Bonding Screw

Item No. | 2568

For equipotential bonding/functional bonding.



X63 Accessories Holder

Item No. | 2763-1

Used for fitting junction boxes, electrical sockets, or other items on the tray.



X80 Side Accessories Holder

Item No. | 2780-1

Used for fitting junction boxes, electrical sockets, or other items on the tray. The fitting is on one edge of the plate and is mounted on two transverse trays (G2).



X65 Tray Cover | L=1000 mm

Item No. | 2765-Wide

Length 1000 mm. Width 60, 120, 220, 320 and 420 cm. The cap protects the cables from welding sparks and falling items (G3).



Vertical Connector

Item No. | 7700-111

For connecting vertical and horizontal cable trays (K5-7).



X72 Safety Cap | 100-pack

Item No. | 2572-Diameter

For 4, 5 and 6 mm wire.
 Ø 4 X-Tray Width 60
 Ø 5 X-Tray Width 120, 220, 320
 Ø 6 X-Tray Width 420



L-Divider

Item No. | 2764 45-2300

Are used in order to separate different types of cables.



X75 Bolt Cutter

Item No. | 2575

Strong bolt cutter with an angled head for easy access.



X76 13 mm Spanner

Item No. | 2576

We only use M8 carriage bolts so this is the only spanner you require.



A,B,F



B

Self-drilling screws

Item No. | 7100-070

For mounting certain fittings. Surface finish FZB. Included in 7700-015, 7700-065 and 7700-066.

Knurled Locking Plug

Item No. | 7500-191

Included to fix Post Bracket Top (7700-015) and the Top Corner Bracket (7700-066) at the top of the post (B1-2). Plastic.



X77 Wire Cutting Machine

Item No. | 2577

Unique and fast wire cutting machine that offers completely grade-free cutting of wire up to 6 mm. Made by Klauke with a guarantee of 10,000 cuts. Bag, battery and charger included.

Item No. | 2577-1 Battery Bosch Li-Ion 18V/20Ah

Item No. | 2577-2 Spare Blade kit

Art. No	Description
0701-2300	X-Tray 60x60 L=2300 mm / Graphite black Zinc
0711-2300	X-Tray 120x60 L=2300 mm / Graphite black Zinc
0721-2300	X-Tray 220x60 L=2300 mm / Graphite black Zinc
0731-2300	X-Tray 320x60 L=2300 mm / Graphite black Zinc
0741-2300	X-Tray 420x60 L=2300 mm / Graphite black Zinc
1722-2300	X-Tray G120x150 L=2300 mm / Graphite black Zinc
1752-2300	X-Tray Mini 30x22 L=2300 mm / Graphite black Zinc
1752-1200	X-Tray Mini 30x22 L=1200 mm / Graphite black Zinc
2568	X68 Equipotential Bonding Screw / Brass
2572-4	X72 Safety Cap 4 mm (100 pcs)
2572-5	X72 Safety Cap 5 mm (100 pcs)
2572-6	X72 Safety Cap 6 mm (100 pcs)
2575	X75 Bolt Cutter
2576	X76 13 mm Spanner
2577	X77 Wire Cutting Machine, Battery powered
2701	X1 Fitting / Graphite black Zinc
2702	X2 Fitting / Graphite black Zinc
2703	X3 Angled Fitting / Graphite black Zinc
2704	X4 Fitting / Graphite black Zinc
2705	X5 Joining Fitting (20 pcs) incl. bolt & nut / Graphite black Zinc
2761	X61 Bolt M8x27 (40 pcs) / Graphite black Zinc
2762	X62 Flange Nut M8 (40 pcs) / Graphite black Zinc
2710-1	X10 Bracket / Graphite black Zinc
2710-2	X10 Mini Bracket / Graphite black Zinc
2711-240	X11 Pendant Premium 240 / Graphite black Zinc
2711-480	X11 Pendant Premium 480 / Graphite black Zinc
2714-280	X14 Pendant 280 / Graphite black Zinc
2715-120	X15 Cantilever 60 -120 / Graphite black Zinc
2715-220	X15 Cantilever 220 / Graphite black Zinc
2715-320	X15 Cantilever 320 / Graphite black Zinc
2715-420	X15 Cantilever 420 / Graphite black Zinc
2763-1	X63 Accessories Holder / Graphite black Zinc
2764 45-2300	L-Divider 45x2300 Black Zinc
2765-60	X65 X-Tray Cover 60x1000 mm / RAL 9011 Graphite black
2765-120	X65 X-Tray Cover 120x1000 mm / RAL 9011 Graphite black
2765-220	X65 X-Tray Cover 220x1000 mm / RAL 9011 Graphite black
2765-320	X65 X-Tray Cover 320x1000 mm / RAL 9011 Graphite black
2765-420	X65 X-Tray Cover 420x1000 mm / RAL 9011 Graphite black
2780-1	X80 Side Accessories Holder Graphite black Zinc
279.28.720	Cable Bridge, small Zink yellow
279.21.784	Cable Bridge, small Graphite black
7100-070	Self Drilling Screw, washer head 4.2x19 / Zinc Plated
7500-191	Knurled Locking Plug
7700-014	Post Bracket X-Guard / Graphite black Zinc
7700-015	Post Bracket Top / Graphite black Zinc
7700-065 *	Corner Bracket X-Guard / Graphite black Zinc
7700-066 *	Top Corner Bracket X-Guard / Graphite black Zinc
7700-032	Cantilever Holder 50x50 X-Guard / Graphite black Zinc
7700-032-2	Cantilever Holder High 50x50 X-Guard / Graphite black Zinc
7700-037	Cantilever Holder Aluminum Rail X-Guard / Graphite black Zinc
7700-060	Adjustable Post Fitting X-Guard / Graphite black Zinc
7700-072	Adjustable Corner Post Fitting X-Guard / Graphite black Zinc
7700-083	Post Cantilever Holder X-Guard / Graphite black Zinc
7700-084	Mesh Panel Mini Bracket X-Guard / Graphite black Zinc
7700-090	Mesh Panel Bracket X-Guard / Graphite black Zinc
7700-111	Vertical Connector Graphite black Zinc
7700-188	Cantilever Holder 70x70 X-Guard / Graphite black Zinc
7700-188-2	Cantilever Holder High 70x70 X-Guard / Graphite black Zinc
9307	X-Tray Demokit X-Guard / Graphite black Zinc

* Only Corner Bracket, not Post Bracket. (Post Bracket 7700-014 purchased separately, previously packed together.)

For installation instructions - please check our X-Tray for X-Guard brochure

Order demokit

You can also order a demokit of cable trays, brackets and fittings for X-Guard (Item No. 9307).

X-Tray comes in a large range. If there is anything you cannot find, please ask us. Most items can be Graphite black galvanized with a few weeks delivery date. Special colours are available - even Zinc Plated if your machine is lighter than Graphite black.

SnapperWorks CAD program gives you immediate control of your cables

SnapperWorks pairs X-Tray cable trays with X-Guard machine guards, giving you immediate control of your cables.

Benefits of X-Tray for X-Guard

- Cost-effective
- Quick fittings designed for machine guards
- Graphite black galvanized for a perfect match with X-Guard (other colours available)
- Several cable routing options
- All bundled and delivered on the same pallet
- Timesaving – quick start-up of machine and production thanks to same pallet shipment (quick and easy installation)

Benefits of SnapperWorks

- Custom CAD program for X-Guard and X-Tray
- Easy to learn, just click and drag
- Provides a complete drawing and a list of materials in no time at all
- DWG and DXF files can be imported

Tested and approved

- X-Tray complies with the highest demands on cable routing systems in accordance with IEC 61537
- X-Tray is a complete cable tray system and is available in a larger range in:
 - Zinc Plated FZB
 - Hot Dip Galvanized FZV
 - Stainless 304L
 - Acid-proof 316L

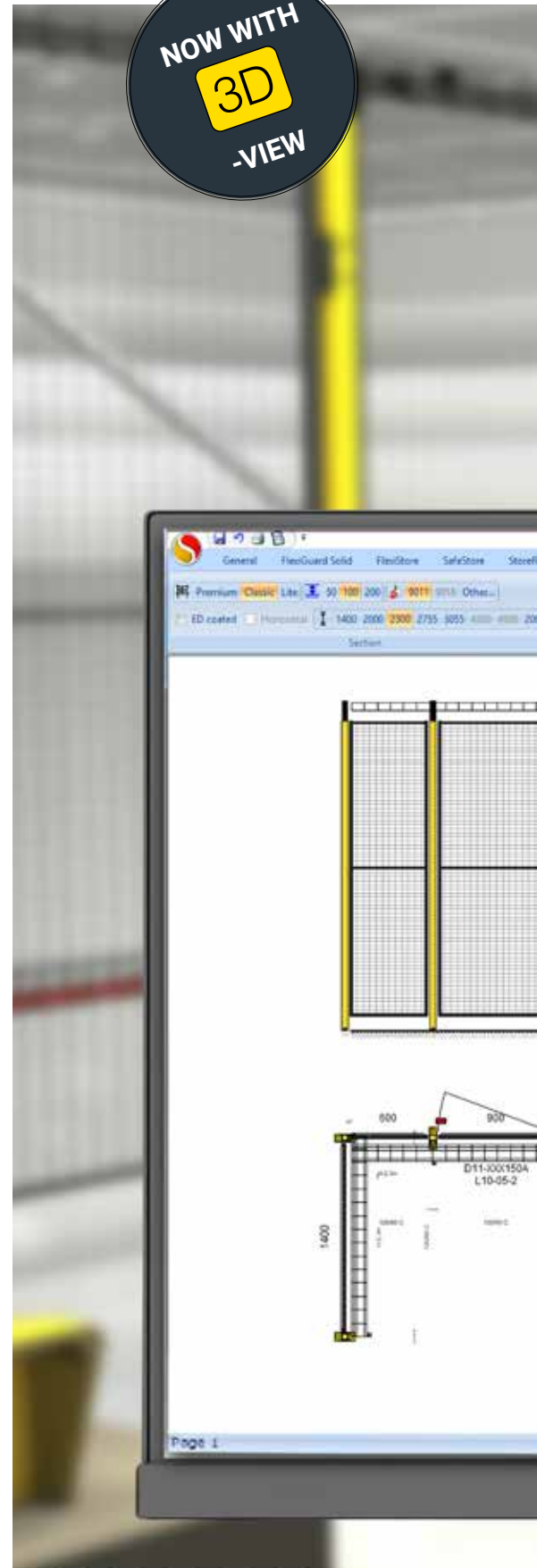



Which cable tray?

What to consider when choosing cable trays

Environment



Environmental requirements for surface treatment and/or classification of installation are based on standards, use, surroundings and specified requirements.

Weight/volume

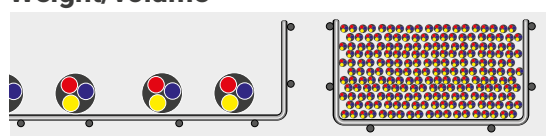

Weight and volume of the cables taking into account future needs.

Extra weight

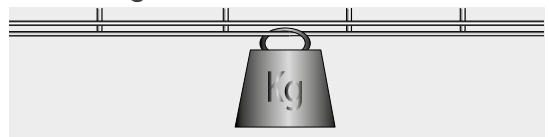

Extra weight from point loads.

Installation



Installations in keyholes, at the top of the post, using brackets or other methods.

Fixing distance

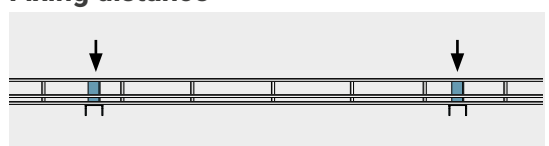

A greater distance between the fixings means less work and lower costs. We recommend a bracket distance of 2.25 metres or, together with X-Guard, adapted to the post distances.

Equipotential bonding

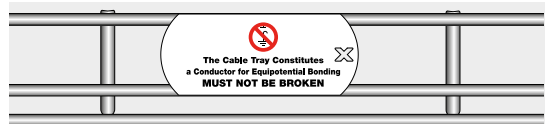

Tested for equipotential bonding.

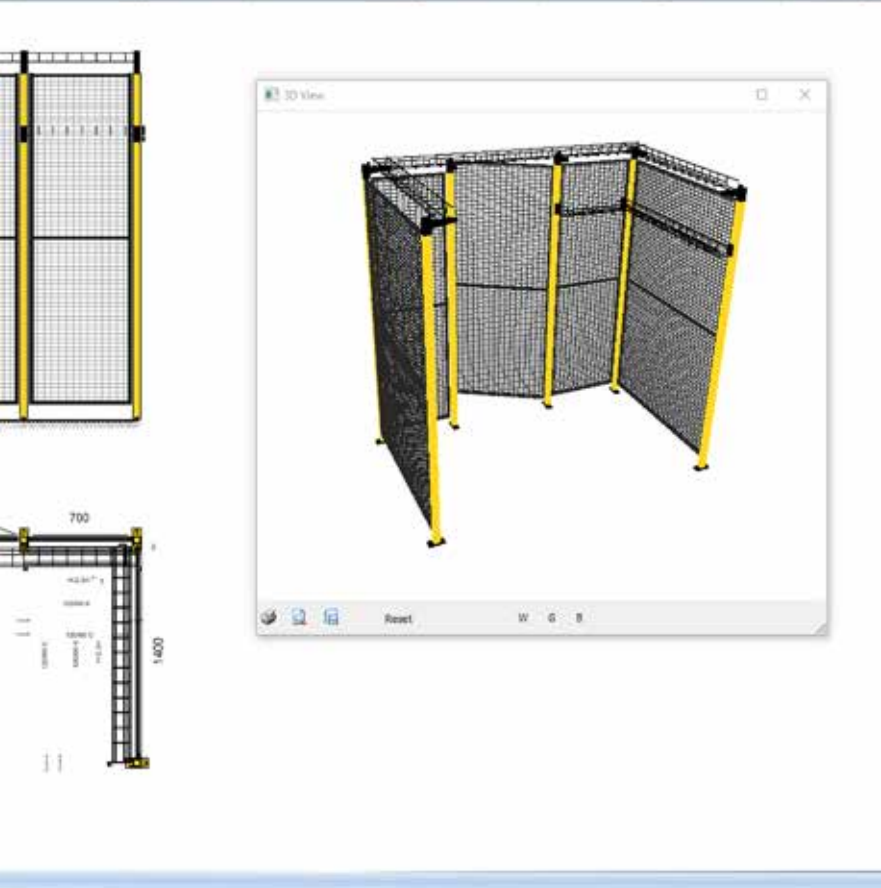
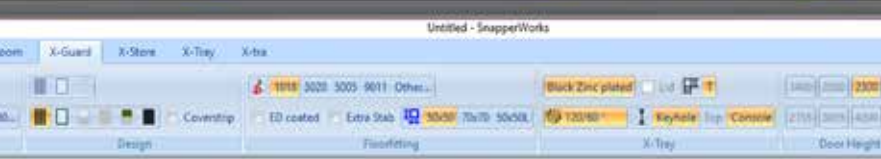



Powder coating

All products come in standard colours but customised colours are available upon request. Whether you want to use your company's signature colours or match the colour of the machine guard with the rest of your machinery, we will find a solution.

You probably associate us with black and yellow, but we feel that we are partly green as well. We pride ourselves on our environmental efforts. All our products have an eco-friendly powder coating. That is to say free from solvents.

Powder coating

Axelent's own product range is powder-coated and free from solvents, thus protecting both the indoor and outdoor environments.

Pre-treated with both iron phosphate and alkaline degreaser. Our ALESTA EP powder coatings can be used at operating temperatures from -20 to +60°C. They contain an epoxy-polyester bonding agent and, due to this epoxy content, can only be used for indoor applications.

Corrosion class

- C2 (indoors)

The film thickness of the coating is 60–150 µm.



ED paint for tough environments

Sometimes machine guards require an extra durable surface to withstand the toughest environments. An ED paint will make the surface resistant to moisture and able to withstand environments with a lot of solvents.

The paint is an electrolytic dip coating used as the final coating in an anti-corrosion treatment. Examples of environments where this paint can be used are food processing, mining, unheated rooms and laundries. It is also highly resistant to oil, petrol and other solvents.

We have considered what lies underneath

Under the ED coating is a zinc phosphate coating for maximum adhesion and to prevent creep corrosion stemming from damage to the finish. The paint is black and can be used as an undercoat for powder

coating, which means that you get a higher corrosion resistance and can choose any colour you want for the finish.

When measuring the paint it lies between 20-25 µm.

Corrosion class

- ED paint + Powder Coating – Matching C3 (not outdoors)



Axelent Safety

Complete safety is not achieved by safe products alone but requires trustworthy products in harness with extensive knowledge and experience. Axelent has a wealth of knowledge and experience of machine safety. We follow developments in the industry very closely and are always at hand to help you keep your machinery up to standard.

On the following pages we have listed the most important things to know about machine safety standards. Would you like us to help you? Contact your nearest sales office.

Summary of Machine Safety Standards

The current version of the Machinery Directive 2006/42/EC (amended by 2009/127/EC) has been in force since December 29, 2009. It is the basis for all machine safety requirements applicable throughout the EU. A number of published European Standards detail requirements that are applicable to Axelent X-Guard. This is a summary of pertinent quotations from these.

1. Fixed guards

Machinery Directive annex 1 chapter 1.4.2.1

"Fixed guards must be fixed by systems that can be opened or removed only with tools.

Their fixing systems must remain attached to the guards or to the machinery when the guards are removed.

Where possible, guards must be incapable of remaining in place without their fixings."

This quite stringent requirement for "no-loss" fasteners has been somewhat softened by the "Guide to application of the Machinery Directive" and a section in the new EN ISO 14120 standard:

"When it is foreseen, e.g. maintenance, that the fixed guard will be removed, the fastenings shall remain attached to the guard or to the machinery.

The requirement does not necessarily apply to fixed guards that are only liable to be removed, for example, when the machinery is completely overhauled, is subject to major repairs, or is dismantled for transfer to another site." (EN ISO 14120 5.19).

EN ISO 14120 chapter 5.3.10

"Where practicable removable guards shall be unable to remain in place without their fixings."

VALUES FOR SAFETY DISTANCES

EN ISO 13857 chapter 4.2.2.1.2 table 2

Dimensions in mm

Height of hazard zone ^c <i>a</i>	Height of protective structure ^a <i>b</i>									
	1000	1200	1400	1600	1800	2000	2200	2400	2500	2700
Horizontal safety distance to hazard zone, <i>c</i>										
2700	0	0	0	0	0	0	0	0	0	0
2600	900	800	700	600	600	500	400	300	100	0
2400	1100	1000	900	800	700	600	400	300	100	0
2200	1300	1200	1000	900	800	600	400	300	0	0
2000	1400	1300	1100	900	800	600	400	0	0	0
1800	1500	1400	1100	900	800	600	0	0	0	0
1600	1500	1400	1100	900	800	500	0			
1400	1500	1400	1100	900	800	0	0			
1200	1500	1400	1100	900	700	0	0			
1000	1500	1400	1000	800	0	0	0			
800	1500	1300	900	600	0	0	0			
600	1400	1300	800	0	0	0	0			
400	1400	1200	400	0	0	0	0			
200	1200	900	0	0	0	0	0			
0	1100	500	0	0	0	0	0			



a Protective structures less than 1000 mm in height are not included because they do not sufficiently restrict movement of the body.

b Protective structures lower than 1400 mm should not be used without additional safety measures.

c For hazard zones above 2700 mm, refer to 4.2.1.

Safety Standards

2. Safety Distances

EN ISO 14120 chapter 5.2.2

"Guards intended for preventing access to hazard zones shall be designed, constructed, and positioned to prevent parts of the body from reaching hazard zones according to ISO 13857. For interlocked movable guards, safety distances according to ISO 13855 shall also be fulfilled."

3. Distances to impede free access

EN ISO 13857

"A protective structure can be used to restrict the free movement of the lower limbs under protective structures. When this method has to be used, distances are given in annex A in relation to the height to the protective structure."

4. Regular openings for persons of 14 years of age and above

EN ISO 13857 chapter 4.2.4.1

Axelent's X-Guard Premium has an aperture of 19 x 49 mm which requires a safety distance of 120 mm, Axelent's other machine guard systems have an aperture of 29 x 49 mm which requires a safety distance of 200 mm (for further information see EN ISO 13857 chapter 4.2.4.1 table 4).

5. Viewing

EN ISO 14120 chapter 5.2.4

"Where viewing of the process is required, guards shall be designed and constructed to offer adequate viewing. This can eliminate the need for defeating them. See also 5.9."

EN ISO 14120 chapter 5.9

"Where viewing of machine operation is required through the guard, materials shall be selected with suitable properties. If perforate material or wire mesh is used this should be of adequate open area and suitable colour to permit viewing. Viewing will be enhanced if the perforate material is darker than the area observed."

6. Positive location of removable guards

EN ISO 14120 chapter 5.3.10

"Where practicable removable guards shall be unable to remain in place without their fixings."

7. Removal only by tool

EN ISO 14120 chapter 5.3.9

"Demountable parts of guards shall only be removable with the aid of a tool."

In the same section EN ISO 14120 forbids use of quick release fasteners that can be accessed from outside the guarded area. This requirement has been added to prevent side-stepping of the guard. Users could be tempted to remove a fence panel instead of using an interlocked door and thus enter the danger zone while the machine is running.

A "safe system of work" can prevent that. Axelent supplies the X-key as a special tool for quick release (as standard from inside only). The owner of the machine should limit access to this special tool to authorised

Figure A.1 (EN ISO 13857)

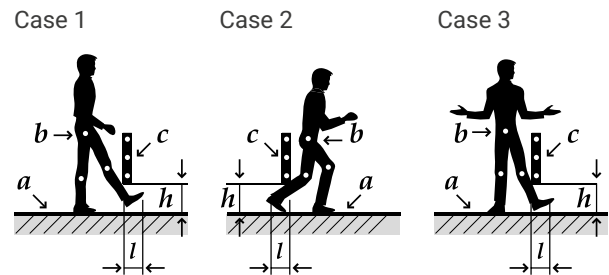

- a - Reference plane
- b - Hip joint
- c - Protective structure
- h - Height up to protective structure
- l - Distance for impedance

Table A.1 (EN ISO 13857)

Height up to protective structure (h)	Distance (l)		
	Case 1	Case 2	Case 3
$h \leq 200$	≥ 340	≥ 665	≥ 290
$200 < h \leq 400$	≥ 550	≥ 765	≥ 615
$400 < h \leq 600$	≥ 850	≥ 950	≥ 800
$600 < h \leq 800$	≥ 950	≥ 950	≥ 900
$800 < h \leq 1000$	≥ 1125	≥ 1195	≥ 1015

Dimensions in mm

Figure A.1 – Impeding free movement under protective structures.

Table A.1 gives distances for particular cases where access of the lower limbs is impeded when the person remains in a standing position (see figure A.1) without any additional support.

Where there is a risk of slipping or misuse, applying the values given in Table A.1 can be inappropriate.

There should be no interpolation between the values in this table. If the height, h, up to the protective structure lies between two values, then the distance for the higher value of h should be used (for further information see EN ISO 13857 chapter 4.3).

persons to prevent circumvention of the guard. At the same time fixed guards need to be easily removed and re-installed to ensure they will be re-installed (compare section 6.4.4.1 b).

8. Selection of guards

EN ISO 14120 chapter 6.4.4.1

"The following types of guard should be used: a) Movable guard, if the foreseeable frequency of access is high (e.g. more than once per week) or if removal or replacement of a fixed guard would be difficult. Movable guards shall be associated with an interlock or an interlock with guard locking (see ISO 14119);

b) Fixed guard only, if the foreseeable frequency of access is low (e.g. less than once per week), its replacement is easy and its removal and replacement are carried out under a safe system of work."

PROTECTION AGAINST REACHING ROUND, DIMENSIONS FOR UPPER LIMBS

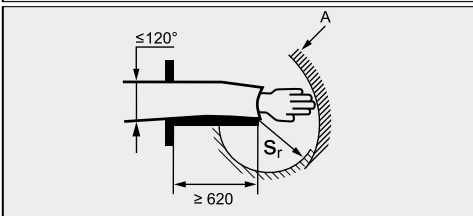
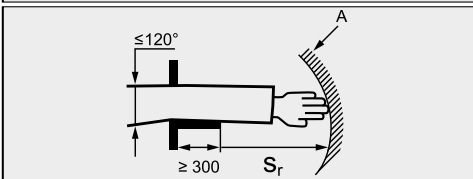
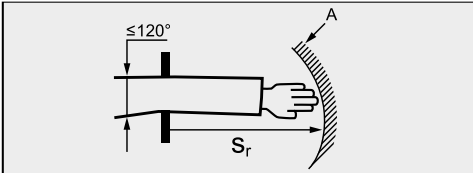

A = Range of arm movement
 Sr = Radial safety distance
 a = Diameter of a circular aperture or width of a square aperture or slot

(For further information see EN ISO 13857 Chapter 4.2.3 table 3)

PROTECTION AGAINST REACHING THROUGH OPENINGS, DIMENSIONS FOR UPPER LIMBS

(EN ISO 13857 Chapter 4.2.4.1 table 4)

The values in the following table apply only to persons who are at least 14 years old. Values in mm.

Part of the body	Figure	Opening	Safety distance		
			Slot	Square	Circular
Fingertip		$e \leq 4$	≥ 2	≥ 2	≥ 2
		$4 < e \leq 6$	≥ 10	≥ 5	≥ 5
Finger up to knuckle where finger joins hand		$6 < e \leq 8$	≥ 20	≥ 15	≥ 5
		$8 < e \leq 10$	≥ 80	≥ 25	≥ 20
Hand		$10 < e \leq 12$	≥ 100	≥ 80	≥ 80
		$12 < e \leq 20$	≥ 120	≥ 120	≥ 120
		$20 < e \leq 30$	$\geq 850^{1)}$	≥ 120	≥ 120
		$30 < e \leq 40$	≥ 850	≥ 200	≥ 120
Arm up to shoulder		$40 < e \leq 120$	≥ 850	≥ 850	≥ 850

The coloured area shows which part of the body is restricted by the size of the opening. For openings > 120 mm the safety distances for reaching over must be used and additional safety measures taken.

¹⁾ If the length of a slot is ≤ 65 mm, the thumb acts as a stop. The safety distance can then be reduced to 200 mm.

* The graphics are owned by Axellent

9. Geometrical factors

EN ISO 12100 chapter 6.2.2.1

"The design of the machine shall be such that, from the main control position, the operator is able to ensure that there are no exposed persons in the danger zones."

10. Measures for the escape and rescue of trapped persons

EN ISO 12100 chapter 6.3.5.3

"Measures for the escape and rescue of trapped persons may consist, e.g. of:

- escape routes and shelters in installations generating operator-trapping hazards;
- arrangements for moving some elements by hand, after an emergency stop;
- arrangements for reversing the movement of some elements;
- anchorage points for descender devices;
- means of communication to enable trapped operators to call for help."

As this is a sample from the applicable standards, we recommend that you read the standard relevant to each application. The basis for any decision on guards and other protective measures should always be a careful risk assessment of the entire machine and process. This document is subject to changes in applicable directives and standards.

The following text and diagrams have been reproduced with the express permission of SIS Förlag AB Stockholm, Sweden, +46 8 555 523 10, HYPERLINK "http://www.sis.se" www.sis.se who also sells the standards referred to in the text.

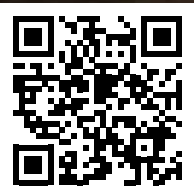
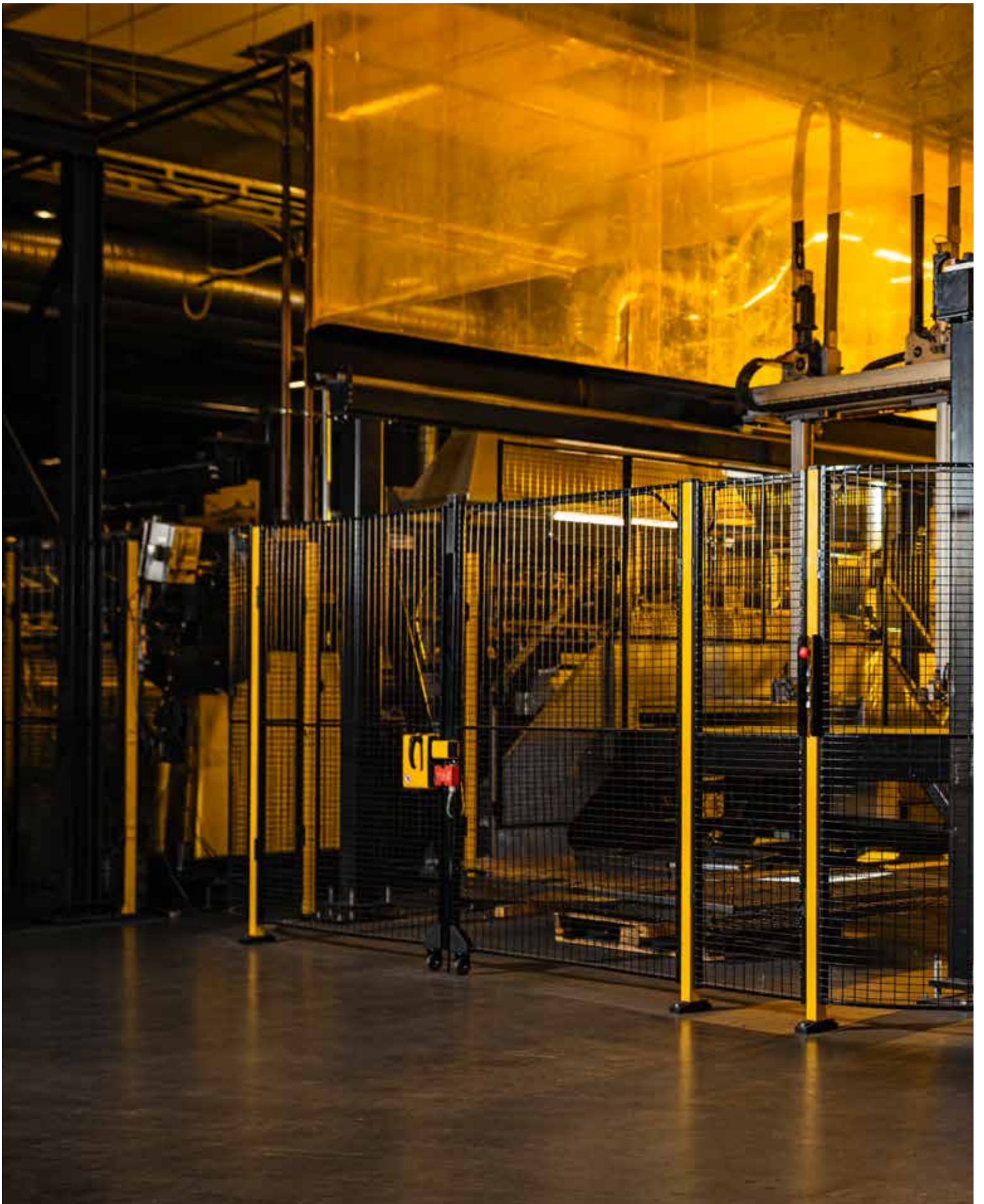

SCAN THE CODE TO VISIT
THE AXELEN ACADEMY